



Section C - Sprinklers
Extended Coverage

TABLE OF CONTENTS

Pendent/Upright	VK600/VK602, 5.6 (81) / 8.0 (115) K factor, pendent C-1
	VK604/VK610, 5.6 (81) K factor, pendent / high pressure pendent C-1
ELO	VK532/VK534, 11.2 (161) K factor, ELO, upright / pendent C-2
	VK608, 11.2 (161) K factor, ELO, pendent C-2
	VK570/VK572, 14.0 (202) K factor, ELO, upright / pendent C-3
Sidewall	VK605/VK606, 5.6 (81) / 8.0 (115) K factor, horizontal sidewall..... C-4
	VK612, 5.6 (81) K factor, horizontal sidewall, high pressure C-4
	Cocoon Sprinklers, VK605/VK612, 5.6 (81) K factor, horizontal sidewall..... C-4
	VK630, 8.0 (115) K factor, horizontal sidewall / domed concealed sidewall C-5
	VK631, 8.0 (115) K factor, HIGH PRESSURE, sidewall / domed concealed sidewall C-5
Concealed	VK614-D/VK616-D, 5.6 (81) / 8.0 (115) K factor, domed concealed pendent C-6
	VK618-D, 11.2 (161) K factor, domed concealed pendent C-6
	Mirage® VK632 / VK634, 5.6 (81) / 8.0 (115) K factor, flat concealed pendent C-7
	Mirage® ELO VK636, 11.2 (161) K factor, flat concealed pendent C-7
	Mirage® Cover Plates (standard, large, square, ELO) C-8
Fusible Link	Fusible Link, upright / pendent C-9
	Fusible Link, horizontal sidewall, high pressure..... C-10

Notes

1. All sprinklers in this section are available with three wraps of Teflon® tape. Add \$1.40 to list price for each sprinkler ordered. When ordering, add a "T" to end of part number.
2. Unless otherwise indicated, all cover plates and escutcheons are sold separately.
3. Cover plates, escutcheons, and sprinklers are available in custom colors at an additional charge. See pages F-8 and F-9 for details.
4. Refer to Viking technical data pages for complete product specifications. You may print or download technical data by visiting www.vikinggroupinc.com.
5. List prices effective May 3, 2010. Supersedes September 2008 list price book.
6. All sales by Viking are subject to the terms & conditions found on the last page of this book.

Teflon® is a registered trademark of DuPont
Microfast® is a registered trademark of The Viking Corporation
Microtech® is a registered trademark of The Viking Corporation
Mirage® is a registered trademark of The Viking Corporation

	Microfast® Model M Quick/Standard Response Extended Coverage Glass Bulb Pendant			
	SIN:	VK600		
	K Factor:	5.6 (81)		
	Thread Size:	1/2 inch NPT		
	Base Part #:	06778B		
Finish	Temp	Part #	IPG	List Price
Standard Brass	135°F	06778BAA	V20.2	\$38.23
Standard Brass	155°F	06778BAB	V20.2	\$38.23
Standard Brass	175°F	06778BAD	V20.2	\$38.23
Chrome	135°F	06778BFA	V20.2	\$41.12
Chrome	155°F	06778BFB	V20.2	\$41.12
Chrome	175°F	06778BFD	V20.2	\$41.12
White-Polyester ²	135°F	06778BMA/W	V20.2	\$41.12
White-Polyester	155°F	06778BMB/W	V20.2	\$41.12
White-Polyester	175°F	06778BMD/W	V20.2	\$41.12
Std Sprinkler Wrench		10896W/B	V20	\$49.85
Wrench for Recessed		13577W/B	V20	\$92.65

	Microfast® Model M Standard/Quick Response Extended Coverage Glass Bulb Pendant			
	SIN:	VK602		
	K Factor:	8.0 (115)		
	Thread Size:	3/4 inch NPT		
	Base Part #:	07077		
Finish	Temp	Part #	IPG	List Price
Standard Brass	135°F	07077AA	V20.2	\$38.23
Standard Brass	155°F	07077AB	V20.2	\$38.23
Standard Brass	175°F	07077AD	V20.2	\$38.23
Chrome	135°F	07077FA	V20.2	\$41.12
Chrome	155°F	07077FB	V20.2	\$41.12
Chrome	175°F	07077FD	V20.2	\$41.12
White-Polyester ²	135°F	07077MA/W	V20.2	\$41.12
White-Polyester	155°F	07077MB/W	V20.2	\$41.12
White-Polyester	175°F	07077MD/W	V20.2	\$41.12
Std Sprinkler Wrench		10896W/B	V20	\$49.85
Wrench for Recessed		13577W/B	V20	\$92.65

	Microfast® Model M Standard/Quick Response Extended Coverage Glass Bulb Pendant			
	SIN:	VK604 ¹		
	K Factor:	5.6 (81)		
	Thread Size:	1/2 inch NPT		
	Base Part #:	10335		
Finish	Temp	Part #	IPG	List Price
Standard Brass	135°F	10335AA	V20.2	\$41.68
Standard Brass	155°F	10335AB	V20.2	\$41.68
Standard Brass	175°F	10335AD	V20.2	\$41.68
Chrome	135°F	10335FA	V20.2	\$44.56
Chrome	155°F	10335FB	V20.2	\$44.56
Chrome	175°F	10335FD	V20.2	\$44.56
White-Polyester ²	135°F	10335MA/W	V20.2	\$44.56
White-Polyester	155°F	10335MB/W	V20.2	\$44.56
White-Polyester	175°F	10335MD/W	V20.2	\$44.56
Std Sprinkler Wrench		10896W/B	V20	\$49.85
Wrench for Recessed		13577W/B	V20	\$92.65

	HIGH PRESSURE - Model M Standard/Quick Response Extended Coverage Glass Bulb Pendant			
	SIN:	VK610		
	K Factor:	5.6 (81)		
	Thread Size:	1/2 inch NPT		
	Base Part #:	12294		
Finish	Temp	Part #	IPG	List Price
Standard Brass	135°F	12294AA	V20.2	\$41.68
Standard Brass	155°F	12294AB	V20.2	\$41.68
Standard Brass	175°F	12294AD	V20.2	\$41.68
Chrome	135°F	12294FA	V20.2	\$44.56
Chrome	155°F	12294FB	V20.2	\$44.56
Chrome	175°F	12294FD	V20.2	\$44.56
White-Polyester ²	135°F	12294MA/W	V20.2	\$44.56
White-Polyester	155°F	12294MB/W	V20.2	\$44.56
White-Polyester	175°F	12294MD/W	V20.2	\$44.56
Std Sprinkler Wrench		10896W/B	V20	\$49.85
Wrench for Recessed		13577W/B	V20	\$92.65

(1) Also listed for high pressure (250 PSI) as VK610 (p/n 12294)

(2) Polyester sprinklers are suitable for decorative applications and are UL listed for corrosion resistance.

NOTE - High Pressure (HP) = Working pressure to 250 psi (1724 kPa)

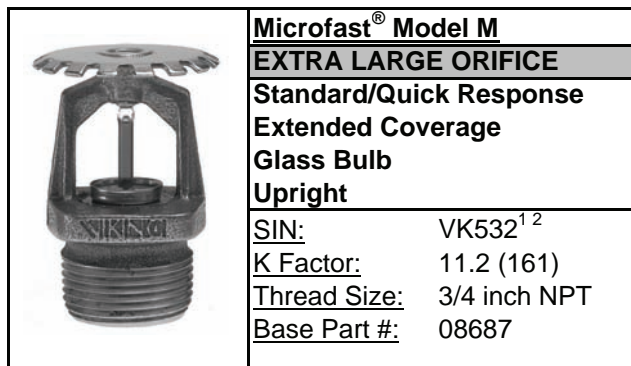

Microfast® Model M
EXTRA LARGE ORIFICE
Standard/Quick Response
Extended Coverage
Glass Bulb
Upright

SIN: VK532^{1 2}
K Factor: 11.2 (161)
Thread Size: 3/4 inch NPT
Base Part #: 08687

Finish	Temp	Part #	IPG	List Price
Standard Brass	155°F	08687AB	V18.1	\$61.89
Standard Brass	175°F	08687AD	V18.1	\$61.89
Standard Brass	200°F	08687AE	V18.1	\$61.89
Standard Brass	286°F	08687AG	V18.1	\$61.89
Chrome	155°F	08687FB	V18.1	\$65.95
Chrome	175°F	08687FD	V18.1	\$65.95
Chrome	200°F	08687FE	V18.1	\$65.95
Chrome	286°F	08687FG	V18.1	\$65.95
White-Polyester ³	155°F	08687MB/W	V18.1	\$65.95
White-Polyester	175°F	08687MD/W	V18.1	\$65.95
White-Polyester	200°F	08687ME/W	V18.1	\$65.95
White-Polyester	286°F	08687MG/W	V18.1	\$65.95
Black-Polyester ³	155°F	08687MB/B	V18	\$65.95
Black-Polyester	175°F	08687MD/B	V18	\$65.95
Black-Polyester	200°F	08687ME/B	V18	\$65.95
Black-Polyester	286°F	08687MG/B	V18	\$65.95
Black-Teflon ^{3,4}	155°F	08687NB	V18	\$77.68
Black-Teflon	175°F	08687ND	V18	\$77.68
Black-Teflon	200°F	08687NE	V18	\$77.68
Black-Teflon	286°F	08687NG	V18	\$77.68
Black-Teflon	OPEN	08687NZ	V18	\$79.82
Std Sprinkler Wrench		05118CW/B	V20	\$104.11

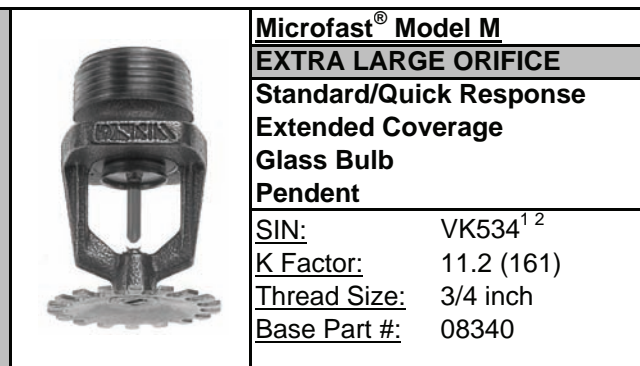

Microfast® Model M
EXTRA LARGE ORIFICE
Standard/Quick Response
Extended Coverage
Glass Bulb
Pendent

SIN: VK534^{1 2}
K Factor: 11.2 (161)
Thread Size: 3/4 inch
Base Part #: 08340

Finish	Temp	Part #	IPG	List Price
Standard Brass	155°F	08340AB	V18.1	\$61.89
Standard Brass	175°F	08340AD	V18.1	\$61.89
Standard Brass	200°F	08340AE	V18.1	\$61.89
Standard Brass	286°F	08340AG	V18.1	\$61.89
Chrome	155°F	08340FB	V18.1	\$65.95
Chrome	175°F	08340FD	V18.1	\$65.95
Chrome	200°F	08340FE	V18.1	\$65.95
Chrome	286°F	08340FG	V18.1	\$65.95
White-Polyester ³	155°F	08340MB/W	V18.1	\$65.95
White-Polyester	175°F	08340MD/W	V18.1	\$65.95
White-Polyester	200°F	08340ME/W	V18.1	\$65.95
White-Polyester	286°F	08340MG/W	V18.1	\$65.95
Black-Polyester ³	155°F	08340MB/B	V18	\$65.95
Black-Polyester	175°F	08340MD/B	V18	\$65.95
Black-Polyester	200°F	08340ME/B	V18	\$65.95
Black-Polyester	286°F	08340MG/B	V18	\$65.95
Black-Teflon ^{3,4}	155°F	08340NB	V18	\$77.68
Black Teflon	175°F	08340ND	V18	\$77.68
Black Teflon	200°F	08340NE	V18	\$77.68
Black Teflon	286°F	08340NG	V18	\$77.68
Black Teflon	OPEN	08340NZ	V18	\$79.82
Std Wrench for ELO Spk		05118CW/B	V20	\$104.11
Wrench for Recessed		11663W/B	V20	\$104.77



Model M
EXTRA LARGE ORIFICE
Standard Response
Extended Coverage
Glass Bulb
Pendent

SIN: VK608¹
K Factor: 11.2 (161)
Thread Size: 3/4 inch NPT
Base Part #: 08339

Finish	Temp	Part #	IPG	List Price
Standard Brass	135°F	08339AA	V18.1	\$61.89
Standard Brass	155°F	08339AB	V18.1	\$61.89
Standard Brass	175°F	08339AD	V18.1	\$61.89
Chrome	135°F	08339FA	V18.1	\$65.95
Chrome	155°F	08339FB	V18.1	\$65.95
Chrome	175°F	08339FD	V18.1	\$65.95
White-Polyester ³	135°F	08339MA/W	V18.1	\$65.95
White-Polyester	155°F	08339MB/W	V18.1	\$65.95
White-Polyester	175°F	08339MD/W	V18.1	\$65.95
Black-Polyester ³	135°F	08339MA/B	V18	\$65.95
Black-Polyester	155°F	08339MB/B	V18	\$65.95
Black-Polyester	175°F	08339MD/B	V18	\$65.95
Black-Teflon ^{3,4}	135°F	08339NA	V18	\$77.68
Black-Teflon	155°F	08339NB	V18	\$77.68
Black-Teflon	175°F	08339ND	V18	\$77.68
Black-Teflon	OPEN	08339NZ	V18	\$79.82
Std Sprinkler Wrench		05118CW/B	V20	\$104.11
Wrench for Recessed		11663W/B	V20	\$104.77

- (1) Light Hazard
- (2) Ordinary Hazard
- (3) Polyester and Teflon® sprinklers are suitable for decorative applications and are UL listed for corrosion resistance.
- (4) Teflon® sprinklers are also available with coated waterways without glass bulbs.

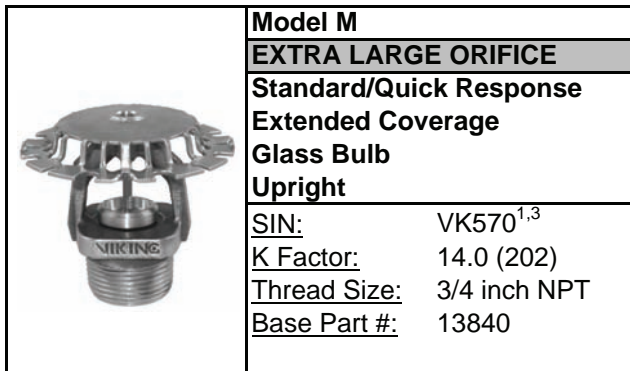

Model M	
EXTRA LARGE ORIFICE	
Standard/Quick Response Extended Coverage Glass Bulb Upright	
<u>SIN:</u>	VK570 ^{1,3}
<u>K Factor:</u>	14.0 (202)
<u>Thread Size:</u>	3/4 inch NPT
<u>Base Part #:</u>	13840

Finish	Temp	Part #	IPG	List Price
Standard Brass	155°F	13840AB	V18.1	\$87.21
Standard Brass	175°F	13840AD	V18.1	\$87.21
Standard Brass	200°F	13840AE	V18.1	\$87.21
Standard Brass	286°F	13840AG	V18.1	\$87.21
Chrome	155°F	13840FB	V18.1	\$92.09
Chrome	175°F	13840FD	V18.1	\$92.09
Chrome	200°F	13840FE	V18.1	\$92.09
Chrome	286°F	13840FG	V18.1	\$92.09
White-Polyester ²	155°F	13840MB/W	V18.1	\$92.09
White-Polyester	175°F	13840MD/W	V18.1	\$92.09
White-Polyester	200°F	13840ME/W	V18.1	\$92.09
White-Polyester	286°F	13840MG/W	V18.1	\$92.09
Black-Polyester ²	155°F	13840MB/B	V18.1	\$92.09
Black-Polyester	175°F	13840MD/B	V18.1	\$92.09
Black-Polyester	200°F	13840ME/B	V18.1	\$92.09
Black-Polyester	286°F	13840MG/B	V18.1	\$92.09
Black-Teflon ²	155°F	13840NB	V18	\$105.76
Black-Teflon	175°F	13840ND	V18	\$105.76
Black-Teflon	200°F	13840NE	V18	\$105.76
Black-Teflon	286°F	13840NG	V18	\$105.76
Wrench for ECOH 14K		07297W/B	V20	\$74.83
Wrench for Recsd ECOH		13032W/B	V20	\$139.05

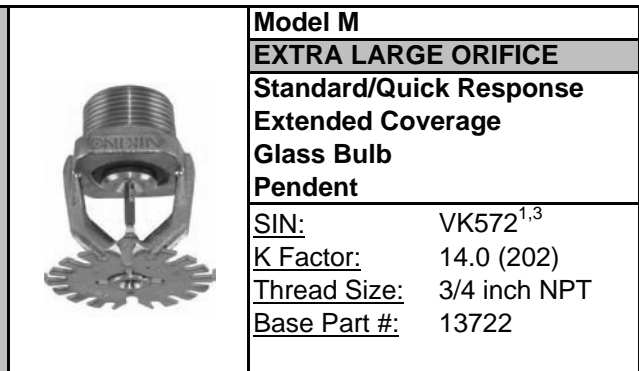

Model M	
EXTRA LARGE ORIFICE	
Standard/Quick Response Extended Coverage Glass Bulb Pendant	
<u>SIN:</u>	VK572 ^{1,3}
<u>K Factor:</u>	14.0 (202)
<u>Thread Size:</u>	3/4 inch NPT
<u>Base Part #:</u>	13722

Finish	Temp	Part #	IPG	List Price
Standard Brass	155°F	13722AB	V18.1	\$67.10
Standard Brass	175°F	13722AD	V18.1	\$67.10
Standard Brass	200°F	13722AE	V18.1	\$67.10
Standard Brass	286°F	13722AG	V18.1	\$67.10
Chrome	155°F	13722FB	V18.1	\$70.84
Chrome	175°F	13722FD	V18.1	\$70.84
Chrome	200°F	13722FE	V18.1	\$70.84
Chrome	286°F	13722FG	V18.1	\$70.84
White-Polyester ²	155°F	13722MB/W	V18.1	\$70.84
White-Polyester	175°F	13722MD/W	V18.1	\$70.84
White-Polyester	200°F	13722ME/W	V18.1	\$70.84
White-Polyester	286°F	13722MG/W	V18.1	\$70.84
Black-Polyester ²	155°F	13722MB/B	V18	\$70.84
Black-Polyester	175°F	13722MD/B	V18	\$70.84
Black-Polyester	200°F	13722ME/B	V18	\$70.84
Black-Polyester	286°F	13722MG/B	V18	\$70.84
Black-Teflon ²	155°F	13722NB	V18	\$81.36
Black-Teflon	175°F	13722ND	V18	\$81.36
Black-Teflon	200°F	13722NE	V18	\$81.36
Black-Teflon	286°F	13722NG	V18	\$81.36
Wrench for ECOH 14K		07297W/B	V20	\$74.83
Wrench for Recsd ECOH		13032W/B	V20	\$139.05

- (1) Ordinary Hazard
- (2) Polyester and Teflon® sprinklers are suitable for decorative applications and are UL listed for corrosion resistance.
- (3) Also listed as quick response for ordinary hazard (refer to technical data page for complete listing/approval data)

	Microfast® Model M Standard/Quick Response Extended Coverage Glass Bulb Horizontal Sidewall			
	SIN: VK605 K Factor: 5.6 (81) Thread Size: 1/2 inch NPT Base Part #: 12120			
Finish	Temp	Part #	IPG	List Price
Standard Brass	135°F	12120AA	V20.2	\$38.23
Standard Brass	155°F	12120AB	V20.2	\$38.23
Standard Brass	175°F	12120AD	V20.2	\$38.23
Chrome	135°F	12120FA	V20.2	\$41.12
Chrome	155°F	12120FB	V20.2	\$41.12
Chrome	175°F	12120FD	V20.2	\$41.12
White-Polyester ¹	135°F	12120MA/W	V20.2	\$41.12
White-Polyester	155°F	12120MB/W	V20.2	\$41.12
White-Polyester	175°F	12120MD/W	V20.2	\$41.12
Black Teflon ¹	135°F	12120NA	V20.2	\$50.63
Black Teflon	155°F	12120NB	V20.2	\$50.63
Black Teflon	175°F	12120ND	V20.2	\$50.63
Std Sprinkler Wrench		10896W/B	V20	\$49.85
Wrench for Recessed		13655W/B	V20	\$104.77

	Microfast® Model M Standard/Quick Response Extended Coverage Glass Bulb Horizontal Sidewall			
	SIN: VK606 K Factor: 8.0 (115) Thread Size: 3/4 inch NPT Base Part #: 13005			
Finish	Temp	Part #	IPG	List Price
Standard Brass	135°F	13005AA	V20.2	\$38.23
Standard Brass	155°F	13005AB	V20.2	\$38.23
Standard Brass	175°F	13005AD	V20.2	\$38.23
Chrome	135°F	13005FA	V20.2	\$41.12
Chrome	155°F	13005FB	V20.2	\$41.12
Chrome	175°F	13005FD	V20.2	\$41.12
White-Polyester ¹	135°F	13005MA/W	V20.2	\$41.12
White-Polyester	155°F	13005MB/W	V20.2	\$41.12
White-Polyester	175°F	13005MD/W	V20.2	\$41.12
Black Teflon ¹	135°F	13005NA	V20.2	\$50.63
Black Teflon	155°F	13005NB	V20.2	\$50.63
Black Teflon	175°F	13005ND	V20.2	\$50.63
Std Sprinkler Wrench		10896W/B	V20	\$49.85
Wrench for Recessed		13655W/B	V20	\$104.77

	HIGH PRESSURE Standard/Quick Response Extended Coverage Glass Bulb Horizontal Sidewall			
	SIN: VK612 K Factor: 5.6 (81) Thread Size: 1/2 inch NPT Base Part #: 12295			
Finish	Temp	Part #	IPG	List Price
Standard Brass	135°F	12295AA	V20.2	\$38.23
Standard Brass	155°F	12295AB	V20.2	\$38.23
Standard Brass	175°F	12295AD	V20.2	\$38.23
Chrome	135°F	12295FA	V20.2	\$41.12
Chrome	155°F	12295FB	V20.2	\$41.12
Chrome	175°F	12295FD	V20.2	\$41.12
White-Polyester ¹	135°F	12295MA/W	V20.2	\$41.12
White-Polyester	155°F	12295MB/W	V20.2	\$41.12
White-Polyester	175°F	12295MD/W	V20.2	\$41.12
Black Teflon ¹	135°F	12295NA	V20.2	\$50.63
Black Teflon	155°F	12295NB	V20.2	\$50.63
Black Teflon	175°F	12295ND	V20.2	\$50.63
Std Sprinkler Wrench		10896W/B	V20	\$49.85
Wrench for Recessed		13655W/B	V20	\$104.77

	COCOON SPRINKLERS² Standard/Quick Response Extended Coverage Glass Bulb Horizontal Sidewall			
	SIN: VK605, VK612 K Factor: 5.6 (81) Thread Size: 1/2 inch NPT Base Part #: 12120, 12295			
Finish	Temp	Part #	IPG	List Price
Chrome	135°F	12120FAK	V00	\$59.65
Chrome	155°F	12120FBK	V00	\$59.65
Chrome	175°F	12120FDK	V00	\$59.65
White-Polyester ¹	135°F	12120MA/WK	V00	\$59.65
White-Polyester	155°F	12120MB/WK	V00	\$59.65
White-Polyester	175°F	12120MD/WK	V00	\$59.65
HIGH PRESSURE - VK612 (base part # 12295)				
Chrome	135°F	12295FAK	V00	\$59.65
Chrome	155°F	12295FBK	V00	\$59.65
Chrome	175°F	12295FDK	V00	\$59.65
White-Polyester ¹	135°F	12295MA/WK	V00	\$59.65
White-Polyester	155°F	12295MB/WK	V00	\$59.65
White-Polyester	175°F	12295MD/WK	V00	\$59.65
Std Sprinkler Wrench		10896W/B	V20	\$49.85
Wrench for Recessed		13655W/B	V20	\$104.77

(1) Polyester and Teflon® sprinklers are suitable for decorative applications and are UL listed for corrosion resistance.

(2) Cocoon sprinklers include sprinkler, sprinkler protective cap, unit cap, 2-piece escutcheon, and three wraps of Teflon® tape.

NOTE - High Pressure (HP) = Working pressure to 250 psi (1724 kPa)

	Microtech[®]			
	Quick Response			
	Extended Coverage			
	Glass Bulb			
	Horizontal Sidewall			
	SIN:	VK630		
	K Factor:	8.0 (115)		
	Thread Size:	3/4 inch NPT		
	Base Part #:	13500		
Finish	Temp	Part #	IPG	List Price
Standard Brass	135°F	13500AA	V20.2	\$38.23
Standard Brass	155°F	13500AB	V20.2	\$38.23
Standard Brass	175°F	13500AD	V20.2	\$38.23
Chrome	135°F	13500FA	V20.2	\$41.12
Chrome	155°F	13500FB	V20.2	\$41.12
Chrome	175°F	13500FD	V20.2	\$41.12
White-Polyester ²	135°F	13500MA/W	V20.2	\$41.12
White-Polyester	155°F	13500MB/W	V20.2	\$41.12
White-Polyester	175°F	13500MD/W	V20.2	\$41.12
Black Teflon ^{2,3}	135°F	13500NA	V20.2	\$50.63
Black Teflon	155°F	13500NB	V20.2	\$50.63
Black Teflon	175°F	13500ND	V20.2	\$50.63
Black-Polyester ²	135°F	13500MA/B	V20.2	\$41.12
Black-Polyester	155°F	13500MB/B	V20.2	\$41.12
Black-Polyester	175°F	13500MD/B	V20.2	\$41.12
Std Sprinkler Wrench		10896W/B	V20	\$49.85
Wrench for Rcsd HSW		13655W/B	V20	\$104.77

	Microtech[®] - HP			
	HIGH PRESSURE (300 psi)			
	Quick Response			
	Extended Coverage			
	Horizontal Sidewall			
	SIN:	VK631		
	K Factor:	8.0 (115)		
	Thread Size:	3/4 inch NPT		
	Base Part #:	16112		
Finish	Temp	Part #	IPG	List Price
Standard Brass	135°F	16112AA	V20.2	\$38.23
Standard Brass	155°F	16112AB	V20.2	\$38.23
Standard Brass	175°F	16112AD	V20.2	\$38.23
Chrome	135°F	16112FA	V20.2	\$41.12
Chrome	155°F	16112FB	V20.2	\$41.12
Chrome	175°F	16112FD	V20.2	\$41.12
White-Polyester ²	135°F	16112MA/W	V20.2	\$41.12
White-Polyester	155°F	16112MB/W	V20.2	\$41.12
White-Polyester	175°F	16112MD/W	V20.2	\$41.12
Black Teflon ^{2,3}	135°F	16112NA	V20.2	\$50.63
Black Teflon	155°F	16112NB	V20.2	\$50.63
Black Teflon	175°F	16112ND	V20.2	\$50.63
Black-Polyester ²	135°F	16112MA/B	V20.2	\$41.12
Black-Polyester	155°F	16112MB/B	V20.2	\$41.12
Black-Polyester	175°F	16112MD/B	V20.2	\$41.12
Std Sprinkler Wrench		10896W/B	V20	\$49.85
Wrench for Rcsd HSW		13655W/B	V20	\$104.77

	Microtech[®] ¹			
	Quick Response			
	Extended Coverage			
	Glass Bulb			
	Domed Concealed Sidewall			
	SIN:	VK630-D		
	K Factor:	8.0 (115)		
	Thread Size:	3/4 inch NPT		
	Base Part #:	13500A-X		
Finish	Temp	Part #	IPG	List Price
Standard Brass	135°F	13500AAX	V15.4	\$56.84
Standard Brass	175°F	13500ADX	V15.4	\$56.84
Spk Wrench Domed Cncl		13655W/B	V20	\$104.77

	Microtech[®] ¹ - HP			
	HIGH PRESSURE (300 psi)			
	Quick Response			
	Extended Coverage			
	Domed Concealed Sidewall			
	SIN:	VK631-D		
	K Factor:	8.0 (115)		
	Thread Size:	3/4 inch NPT		
	Base Part #:	16112A-X		
Finish	Temp	Part #	IPG	List Price
Standard Brass	135°F	16112AAX	V15.4	\$56.84
Standard Brass	175°F	16112ADX	V15.4	\$56.84
Spk Wrench Domed Cncl		13655W/B	V20	\$104.77

Domed Cover Plate¹				
Base Part #:		13501		
Finish	Temp	Part #	IPG	List Price
Chrome	135°F	13501FA	V15.3	\$22.82
Chrome	165°F	13501FC	V15.3	\$22.82
Painted White	135°F	13501MA/SW1004	V15.3	\$22.82
Painted White	165°F	13501MC/SW1004	V15.3	\$22.82
Painted Ivory	135°F	13501MA/SW1634	V15.3	\$28.60
Painted Ivory	165°F	13501MC/SW1634	V15.3	\$28.60
Painted Black	135°F	13501MA/SW1007	V15.3	\$28.60
Painted Black	165°F	13501MC/SW1007	V15.3	\$28.60



(1) Cover plates sold separately. Cover plates are also available in custom colors at an additional charge (see pg F-8).
 (2) Polyester and Teflon® sprinklers are suitable for decorative applications and are UL listed for corrosion resistance.
 (3) Teflon® sprinklers are available without glass bulbs and with coated waterways.



Domed Concealed¹
Standard/Quick Response
Extended Coverage
Glass Bulb
Pendent

SIN: VK614-D
K Factor: 5.6 (81)
Thread Size: 1/2 inch NPT
Base Part #: 06778BA-X

Finish	Temp	Part #	IPG	List Price
Standard Brass	155°F	06778BABX	V15.4	\$64.52
Standard Brass	175°F	06778BADX	V15.4	\$64.52
Spk Wrench for Domed		13577W/B	V20	\$92.65



Domed Concealed¹
Standard/Quick Response
Extended Coverage
Glass Bulb
Pendent

SIN: VK616-D
K Factor: 8.0 (115)
Thread Size: 3/4 inch NPT
Base Part #: 07077A-X

Finish	Temp	Part #	IPG	List Price
Standard Brass	155°F	07077ABX	V15.4	\$64.52
Standard Brass	175°F	07077ADX	V15.4	\$64.52
Spk Wrench for Domed		13577W/B	V20	\$92.65



EXTRA LARGE ORIFICE

Domed Concealed¹
Standard/Quick Response
Extended Coverage
Glass Bulb
Pendent

SIN: VK618-D
K Factor: 11.2 (161)
Thread Size: 3/4 inch NPT
Base Part #: 08339A-X

Finish	Temp	Part #	IPG	List Price
Standard Brass	155°F	08339ABX	V15.4	\$63.35
Standard Brass	175°F	08339ADX	V15.4	\$63.35
Spk Wrench for Domed		11663W/B	V20	\$104.77

Domed Cover Plate¹
Base Part #: 12381

Finish	Temp	Part #	IPG	List Price
Chrome	135°F	12381FA	V15.3	\$22.82
Chrome	165°F	12381FC	V15.3	\$22.82
Painted White	135°F	12381MA/SW1004	V15.3	\$22.82
Painted White	165°F	12381MC/SW1004	V15.3	\$22.82
Painted Ivory	135°F	12381MA/SW1634	V15.3	\$28.60
Painted Ivory	165°F	12381MC/SW1634	V15.3	\$28.60
Painted Black	135°F	12381MA/SW1007	V15.3	\$28.60
Painted Black	165°F	12381MC/SW1007	V15.3	\$28.60
Bright Brass	135°F	12381BA/B	V15.3	\$28.60
Bright Brass	165°F	12381BC/B	V15.3	\$28.60



(1) Cover plates sold separately. Covers are also available in custom colors at an additional charge (see page F-8).



Mirage^{®1}
Quick Response
Extended Coverage
Glass Bulb
Concealed Pendant

SIN: VK632
K Factor: 5.6 (81)
Thread Size: 1/2 inch NPT
Base Part #: 14613A

Finish	Temp	Part #	IPG	List Price
Standard Brass	135°F	14613AA	V16.4	\$51.90
Standard Brass	155°F	14613AB	V16.4	\$51.90
Standard Brass	175°F	14613AD	V16.4	\$51.90
Standard Brass	200°F	14613AE	V16.4	\$51.90
Heavy Duty Spk Wrench		14047W/B	V20	\$96.01
Cabinet Wrench/Cap Tool		14031	V20	\$19.67



Mirage^{®1}
Quick Response
Extended Coverage
Glass Bulb
Concealed Pendant

SIN: VK634
K Factor: 8.0 (115)
Thread Size: 3/4 inch NPT
Base Part #: 14535A

Finish	Temp	Part #	IPG	List Price
Standard Brass	135°F	14535AA	V16.4	\$51.90
Standard Brass	155°F	14535AB	V16.4	\$51.90
Standard Brass	175°F	14535AD	V16.4	\$51.90
Standard Brass	200°F	14535AE	V16.4	\$51.90
Heavy Duty Spk Wrench		14047W/B	V20	\$96.01
Cabinet Wrench/Cap Tool		14031	V20	\$19.67



ELO Mirage^{®1}
Quick Response
Extended Coverage
Fusible Link
Concealed Pendant

SIN: VK636
K Factor: 11.2 (161)
Thread Size: 3/4 inch NPT
Base Part #: 16102A

Finish	Temp	Part #	IPG	List Price
Standard Brass	165°F	16102AC	V16.4A	\$57.10
Standard Brass	205°F	16102AE	V16.4A	\$57.10
Heavy Duty Spk Wrench		15467W/B	V20	\$96.01
Cabinet Wrench/Cap Tool		15466	V20	\$19.67

(1) Cover plates sold separately. See following page for details.

Standard Cover Plate				
<i>Diameter = 2-3/4 inches</i>				
<i>Use w/ VK632 and VK634</i>				
Finish	Temp	Part #	IPG	List
Polished Chrome	135°F	13504FA	V16.2	\$22.99
Polished Chrome	165°F	13504FC	V16.2	\$22.99
White	135°F	13504MA/SW1004	V16.2	\$22.99
White	165°F	13504MC/SW1004	V16.2	\$22.99
Ivory	135°F	13504MA/SW1634	V16.2	\$28.77
Ivory	165°F	13504MC/SW1634	V16.2	\$28.77
Black	135°F	13504MA/SW1007	V16.2	\$28.77
Black	165°F	13504MC/SW1007	V16.2	\$28.77
Bright Brass	135°F	13504BA	V16.2	\$28.77
Bright Brass	165°F	13504BC	V16.2	\$28.77
Brushed Brass	135°F	13504BA/B	V16.2	\$28.77
Brushed Brass	165°F	13504BC/B	V16.2	\$28.77
Antique Brass	135°F	13504BA/A	V16.2	\$28.77
Antique Brass	165°F	13504BC/A	V16.2	\$28.77
Brushed Copper	135°F	13504EA/B	V16.2	\$28.77
Brushed Copper	165°F	13504EC/B	V16.2	\$28.77
Brushed Chrome	135°F	13504FA/B	V16.2	\$28.77
Brushed Chrome	165°F	13504FC/B	V16.2	\$28.77



Large Cover Plate				
<i>Diameter = 3-5/16 inches</i>				
<i>Use w/ VK632 and VK634</i>				
Finish	Temp	Part #	IPG	List
Polished Chrome	135°F	13642FA	V16.2	\$22.99
Polished Chrome	165°F	13642FC	V16.2	\$22.99
White	135°F	13642MA/SW1004	V16.2	\$22.99
White	165°F	13642MC/SW1004	V16.2	\$22.99
Ivory	135°F	13642MA/SW1634	V16.2	\$28.77
Ivory	165°F	13642MC/SW1634	V16.2	\$28.77
Black	135°F	13642MA/SW1007	V16.2	\$28.77
Black	165°F	13642MC/SW1007	V16.2	\$28.77
Bright Brass	135°F	13642BA	V16.2	\$28.77
Bright Brass	165°F	13642BC	V16.2	\$28.77
Brushed Brass	135°F	13642BA/B	V16.2	\$28.77
Brushed Brass	165°F	13642BC/B	V16.2	\$28.77
Antique Brass	135°F	13642BA/A	V16.2	\$28.77
Antique Brass	165°F	13642BC/A	V16.2	\$28.77
Brushed Copper	135°F	13642EA/B	V16.2	\$28.77
Brushed Copper	165°F	13642EC/B	V16.2	\$28.77
Brushed Chrome	135°F	13642FA/B	V16.2	\$28.77
Brushed Chrome	165°F	13642FC/B	V16.2	\$28.77



Square Cover Plate				
<i>Use w/ VK632 and VK634</i>				
Finish	Temp	Part #	IPG	List
Polished Chrome	135°F	15394FA	V16.5	\$39.56
Polished Chrome	165°F	15394FC	V16.5	\$39.56
White	135°F	15394MA/SW1004	V16.5	\$37.96
White	165°F	15394MC/SW1004	V16.5	\$37.96
Ivory	135°F	15394MA/SW1634	V16.5	\$37.96
Ivory	165°F	15394MC/SW1634	V16.5	\$37.96
Black	135°F	15394MA/SW1007	V16.5	\$37.96
Black	165°F	15394MC/SW1007	V16.5	\$37.96
Bright Brass	135°F	15394BA	V16.5	\$46.30
Bright Brass	165°F	15394BC	V16.5	\$46.30
Brushed Brass	135°F	15394BA/B	V16.5	\$46.30
Brushed Brass	165°F	15394BC/B	V16.5	\$46.30
Antique Brass	135°F	15394BA/A	V16.5	\$46.30
Antique Brass	165°F	15394BC/A	V16.5	\$46.30
Brushed Copper	135°F	15394EA/B	V16.5	\$46.30
Brushed Copper	165°F	15394EC/B	V16.5	\$46.30
Brushed Chrome	135°F	15394FA/B	V16.5	\$46.30
Brushed Chrome	165°F	15394FC/B	V16.5	\$46.30



Mirage ELO Cover Plate				
<i>Diameter = 3-5/16 inches</i>				
<i>Use w/ VK636</i>				
Finish	Temp	Part #	IPG	List
Polished Chrome	135°F	15765FA	V16.2	\$22.99
Polished Chrome	165°F	15765FC	V16.2	\$22.99
White	135°F	15765MA/SW1004	V16.2	\$22.99
White	165°F	15765MC/SW1004	V16.2	\$22.99
Ivory	135°F	15765MA/SW1634	V16.2	\$28.77
Ivory	165°F	15765MC/SW1634	V16.2	\$28.77
Black	135°F	15765MA/SW1007	V16.2	\$28.77
Black	165°F	15765MC/SW1007	V16.2	\$28.77



Cover Plate Installation Tool - Standard



14412
\$8.69

IPG V20

Cover Plate Installation Tool - Large



14867
\$8.69

IPG V20

Cabinet Wrench / Cap Removal Tool





14031
\$19.67

IPG V20

					Microfast® Model M				
					Quick Response				
					Extended Coverage				
					FUSIBLE LINK¹				
Upright Sprinklers									
Finish	Temp	Part #	IPG	List Price					
VK535 - 11.2 (161) K Factor - 3/4 in NPT -UPRIGHT²									
Standard Brass	165°F	14139AC	V18.1	\$64.47					
Standard Brass	205°F	14139AE	V18.1	\$64.47					
Chrome	165°F	14139FC	V18.1	\$67.24					
Chrome	205°F	14139FE	V18.1	\$67.24					
White-Polyester	165°F	14139MC/W	V18.1	\$67.24					
White-Polyester	205°F	14139ME/W	V18.1	\$67.24					
Std Sprinkler Wrench		05118CW/B	V20	\$104.11					

					Microfast® Model M				
					Quick Response				
					Extended Coverage				
					FUSIBLE LINK¹				
Pendent Sprinklers									
Finish	Temp	Part #	IPG	List Price					
VK537 - 11.2 (161) K Factor - 3/4 in NPT -PENDENT²									
Standard Brass	165°F	14611AC	V18.1	\$69.62					
Standard Brass	205°F	14611AE	V18.1	\$69.62					
Chrome	165°F	14611FC	V18.1	\$73.30					
Chrome	205°F	14611FE	V18.1	\$73.30					
White-Polyester	165°F	14611MC/W	V18.1	\$73.30					
White-Polyester	205°F	14611ME/W	V18.1	\$73.30					
Std Sprinkler Wrench		05118CW/B	V20	\$104.11					
Wrench for Recessed		11663W/B	V20	\$104.77					

					Microfast® Model M				
					Quick Response				
					Extended Coverage				
					FUSIBLE LINK¹				
Pendent Sprinklers									
Finish	Temp	Part #	IPG	List Price					
VK601 - 5.6 (81) K Factor - 1/2 in NPT - PENDENT									
Standard Brass	165°F	13969AC	V20.2	\$40.78					
Standard Brass	205°F	13969AE	V20.2	\$40.78					
Chrome	165°F	13969FC	V20.2	\$42.60					
Chrome	205°F	13969FE	V20.2	\$42.60					
White-Polyester	165°F	13969MC/W	V20.2	\$45.79					
White-Polyester	205°F	13969ME/W	V20.2	\$45.79					
Std Sprinkler Wrench		10896W/B	V20	\$49.85					
Wrench for Recessed		13655W/B	V20	\$104.77					

					Microfast® Model M				
					Quick Response				
					Extended Coverage				
					FUSIBLE LINK¹				
Pendent Sprinklers									
Finish	Temp	Part #	IPG	List Price					
VK603 - 8.0 (115) K Factor - 3/4 in NPT - PENDENT									
Standard Brass	165°F	14140AC	V20.2	\$48.31					
Standard Brass	205°F	14140AE	V20.2	\$48.31					
Chrome	165°F	14140FC	V20.2	\$50.48					
Chrome	205°F	14140FE	V20.2	\$50.48					
White-Polyester	165°F	14140MC/W	V20.2	\$52.53					
White-Polyester	205°F	14140ME/W	V20.2	\$52.53					
Std Sprinkler Wrench		10896W/B	V20	\$49.85					
Wrench for Recessed		13655W/B	V20	\$104.77					

					Microfast® Model M				
					Quick Response				
					Extended Coverage				
					FUSIBLE LINK¹				
Pendent Sprinklers									
Finish	Temp	Part #	IPG	List Price					
VK607 - 5.6 (81) K Factor - 1/2 in NPT - PENDENT									
Standard Brass	165°F	13970AC	V20.2	\$46.51					
Standard Brass	205°F	13970AE	V20.2	\$46.51					
Chrome	165°F	13970FC	V20.2	\$48.82					
Chrome	205°F	13970FE	V20.2	\$48.82					
White-Polyester	165°F	13970MC/W	V20.2	\$48.82					
White-Polyester	205°F	13970ME/W	V20.2	\$48.82					
Std Sprinkler Wrench		10896W/B	V20	\$49.85					
Wrench for Recessed		13577W/B	V20	\$92.65					

					Microfast® Model M				
					Quick Response				
					Extended Coverage				
					FUSIBLE LINK¹				
Pendent Sprinklers									
Finish	Temp	Part #	IPG	List Price					
VK617 - 11.2 (161) K Factor - 3/4 in NPT - PENDENT									
Standard Brass	165°F	14141AC	V18.1	\$63.44					
Standard Brass	205°F	14141AE	V18.1	\$63.44					
Chrome	165°F	14141FC	V18.1	\$66.22					
Chrome	205°F	14141FE	V18.1	\$66.22					
White-Polyester	165°F	14141MC/W	V18.1	\$68.71					
White-Polyester	205°F	14141ME/W	V18.1	\$68.71					
Std Sprinkler Wrench		05118CW/B	V20	\$104.11					
Wrench for Recessed		11663W/B	V20	\$104.77					

(1) Select fusible link sprinklers are also available in painted black and black Teflon® finish. Contact customer service for price and availability.

(2) Ordinary Hazard

					Microfast® Model M				
					Quick Response				
					Extended Coverage				
					FUSIBLE LINK¹				
Horizontal Sidewall									
Finish	Temp	Part #	IPG	List Price					
VK609 - 5.6 (81) K Factor - 1/2 in NPT -HSW (QREC)									
Standard Brass	165°F	13971AC	V20.2	\$42.91					
Standard Brass	205°F	13971AE	V20.2	\$42.91					
Chrome	165°F	13971FC	V20.2	\$45.99					
Chrome	205°F	13971FE	V20.2	\$45.99					
White-Polyester	165°F	13971MC/W	V20.2	\$45.99					
White-Polyester	205°F	13971ME/W	V20.2	\$45.99					
Std Sprinkler Wrench		10896W/B	V20	\$49.85					
Wrench for Recessed		13655W/B	V20	\$104.77					

					Microfast® Model M				
					Quick Response				
					Extended Coverage				
					FUSIBLE LINK¹				
Horizontal Sidewall									
HIGH PRESSURE									
Finish	Temp	Part #	IPG	List Price					
VK613 - 5.6 (81) K Factor - 1/2 in NPT - HSW (HP)									
Standard Brass	165°F	13973AC	V20.2	\$42.91					
Standard Brass	205°F	13973AE	V20.2	\$42.91					
Chrome	165°F	13973FC	V20.2	\$45.99					
Chrome	205°F	13973FE	V20.2	\$45.99					
White-Polyester	165°F	13973MC/W	V20.2	\$45.99					
White-Polyester	205°F	13973ME/W	V20.2	\$45.99					
Std Sprinkler Wrench		10896W/B	V20	\$49.85					
Wrench for Recessed		13655W/B	V20	\$104.77					

					Microfast® Model M				
					Quick Response				
					Extended Coverage				
					FUSIBLE LINK¹				
Pendant									
HIGH PRESSURE									
Finish	Temp	Part #	IPG	List Price					
VK611 - 5.6 (81) K Factor - 1/2 in NPT - Pendant (HP)									
Standard Brass	165°F	13972AC	V20.2	\$46.51					
Standard Brass	205°F	13972AE	V20.2	\$46.51					
Chrome	165°F	13972FC	V20.2	\$48.82					
Chrome	205°F	13972FE	V20.2	\$48.82					
White-Polyester	165°F	13972MC/W	V20.2	\$48.82					
White-Polyester	205°F	13972ME/W	V20.2	\$48.82					
Std Sprinkler Wrench		10896W/B	V20	\$49.85					
Wrench for Recessed		13577W/B	V20	\$92.65					

(1) Select fusible link sprinklers are also available in painted black and black Teflon® finish.
 Contact customer service for price and availability.

NOTE - High Pressure (HP) = Working pressure to 250 psi (1724 kPa)

