



**Section B - Sprinklers**  
**Standard Coverage, Quick Response**

**TABLE OF CONTENTS**

Pendent/Upright (glass bulb)	VK325/VK329, 2.8 (40) K factor, upright / pendent ..... B-1 VK327/VK331, 4.2 (60) K factor, upright / pendent ..... B-2 VK300/VK302, 5.6 (81) K factor, upright / pendent ..... B-3 VK350/VK352, 8.0 (115) K factor, upright / pendent (3/4" NPT) ..... B-4 VK350/VK352, 8.0 (115) K factor, upright / pendent (1/2" NPT) - REPLACEMENT ..... B-5
Conventional	VK310/VK354, 5.6 (81) / 8.0 (115) K factor, conventional ..... B-6
Sidewall	VK333/VK304, 2.8 (40) / 5.6 (81) K factor, horizontal sidewall ..... B-7 VK305/VK306, 5.6 (81) K factor, horizontal sidewall / vertical sidewall ..... B-8 VK360, 8.0 (115) K factor, horizontal sidewall ..... B-8
Concealed	VK302-D/VK352-D, 5.6 (81) / 8.0 (115) K factor, domed concealed pendent ..... B-9 VK402, 5.6 (81) K factor, flush pendent ..... B-9 Mirage® VK461/VK465, 2.8 (40) / 4.2 (60) K factor, flat concealed pendent ..... B-10 Mirage® VK462/VK464, 5.6 (81) / 8.0 (115) K factor, flat concealed pendent ..... B-10 Mirage® VK463, 5.6 (81) K factor, flat concealed pendent, high pressure ..... B-10 Mirage® VK469, 11.2 (161) K factor, ELO, flat concealed pendent ..... B-10 Mirage® MRI Room Concealed Sprinklers (VK462/VK464) ..... B-10 Mirage® Cover Plates (standard, large, square, ELO, clean room) ..... B-11 Mirage® Adjustable Concealed Sprinklers (VK461/VK465/VK462) ..... B-12 VK408, 5.6 (81) K factor, flat concealed horizontal sidewall and cover plate ..... B-13
Fusible Link	Fusible Link, upright / pendent ..... B-14 Fusible Link, horizontal sidewall / vertical sidewall / conventional ..... B-15 Fusible Link, high pressure ..... B-16
High Pressure	VK340/VK342, high pressure, 2.8 (40) K factor, upright / pendent, HP ..... B-17 VK315/VK317, high pressure, 5.6 (81) K factor, upright / pendent, HP ..... B-18 VK344/VK319, high pressure, 2.8 (40) / 5.6 (81) K factor, horizontal sidewall, HP ..... B-19
Stainless Steel	VK338/VK339, stainless steel, 5.6 (81) K factor, upright / pendent ..... B-20
Cocoon Spk	Cocoon Sprinklers, 5.6 (81) K factor, pendent / horizontal sidewall ..... B-20

**Notes**

1. All sprinklers in this section are available with three wraps of Teflon® tape. Add \$1.40 to list price for each sprinkler ordered. When ordering, add a "T" to end of part number.
2. Unless otherwise indicated, all cover plates and escutcheons are sold separately.
3. Cover plates, escutcheons, and sprinklers are available in custom colors at an additional charge. See pages F-8 and F-9 for details.
4. Refer to Viking technical data pages for complete product specifications ([www.vikinggroupinc.com](http://www.vikinggroupinc.com)).
5. List prices effective May 3, 2010. Supersedes September 2008 list price book.
6. All sales by Viking are subject to the terms & conditions found on the last page of this book.

*Teflon® is a registered trademark of DuPont*

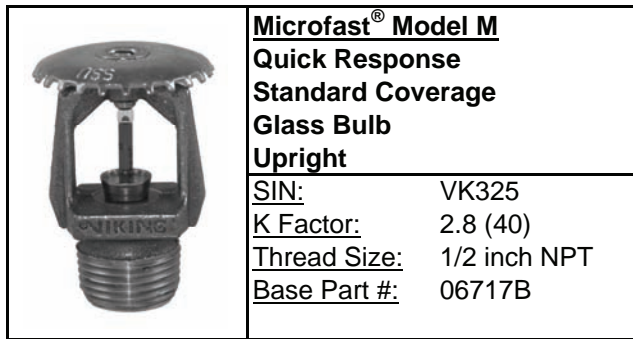

**Microfast® Model M**  
**Quick Response**  
**Standard Coverage**  
**Glass Bulb**  
**Upright**  
**SIN:** VK325  
**K Factor:** 2.8 (40)  
**Thread Size:** 1/2 inch NPT  
**Base Part #:** 06717B

Finish	Temp	Part #	IPG	List Price
Standard Brass	155°F	06717BAB	V14.2	\$38.56
Standard Brass	175°F	06717BAD	V14.2	\$38.56
Standard Brass	200°F	06717BAE	V14.2	\$38.56
Standard Brass	286°F	06717BAG	V14.2	\$38.56
Chrome	155°F	06717BFB	V14.2	\$41.32
Chrome	175°F	06717BFD	V14.2	\$41.32
Chrome	200°F	06717BFE	V14.2	\$41.32
Chrome	286°F	06717BFG	V14.2	\$41.32
White-Polyester <sup>1</sup>	155°F	06717BMB/W	V14.2	\$41.32
White-Polyester	175°F	06717BMD/W	V14.2	\$41.32
White-Polyester	200°F	06717BME/W	V14.2	\$41.32
White-Polyester	286°F	06717BMG/W	V14.2	\$41.32
Black-Polyester <sup>1</sup>	155°F	06717BMB/B	V20	\$42.53
Black-Polyester	175°F	06717BMD/B	V20	\$42.53
Black-Polyester	200°F	06717BME/B	V20	\$42.53
Black-Polyester	286°F	06717BMG/B	V20	\$42.53
Black-Teflon <sup>1,2</sup>	155°F	06717BNB	V20	\$51.71
Black-Teflon	175°F	06717BND	V20	\$51.71
Black-Teflon	200°F	06717BNE	V20	\$51.71
Black-Teflon	286°F	06717BNG	V20	\$51.71
Std sprinkler Wrench		10896W/B	V20	\$49.85

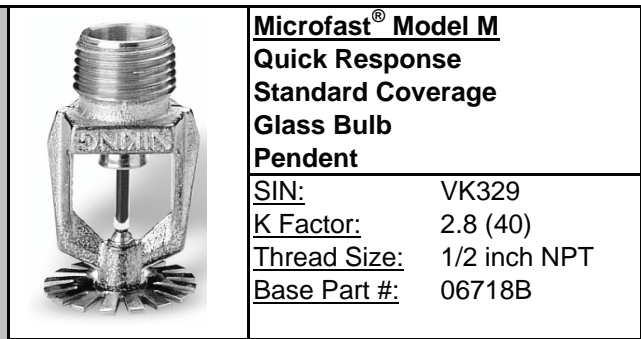

**Microfast® Model M**  
**Quick Response**  
**Standard Coverage**  
**Glass Bulb**  
**Pendent**  
**SIN:** VK329  
**K Factor:** 2.8 (40)  
**Thread Size:** 1/2 inch NPT  
**Base Part #:** 06718B

Finish	Temp	Part #	IPG	List Price
Standard Brass	155°F	06718BAB	V14.2	\$38.56
Standard Brass	175°F	06718BAD	V14.2	\$38.56
Standard Brass	200°F	06718BAE	V14.2	\$38.56
Standard Brass	286°F	06718BAG	V14.2	\$38.56
Chrome	155°F	06718BFB	V14.2	\$41.32
Chrome	175°F	06718BFD	V14.2	\$41.32
Chrome	200°F	06718BFE	V14.2	\$41.32
Chrome	286°F	06718BFG	V14.2	\$41.32
White-Polyester <sup>1</sup>	155°F	06718BMB/W	V14.2	\$41.32
White-Polyester	175°F	06718BMD/W	V14.2	\$41.32
White-Polyester	200°F	06718BME/W	V14.2	\$41.32
White-Polyester	286°F	06718BMG/W	V14.2	\$41.32
Black-Polyester <sup>1</sup>	155°F	06718BMB/B	V20	\$42.53
Black-Polyester	175°F	06718BMD/B	V20	\$42.53
Black-Polyester	200°F	06718BME/B	V20	\$42.53
Black-Polyester	286°F	06718BMG/B	V20	\$42.53
Black-Teflon <sup>1,2</sup>	155°F	06718BNB	V20	\$51.71
Black-Teflon	175°F	06718BND	V20	\$51.71
Black-Teflon	200°F	06718BNE	V20	\$51.71
Black-Teflon	286°F	06718BNG	V20	\$51.71
Std sprinkler Wrench		10896W/B	V20	\$49.85
Wrench for Rcstd w/Caps		12144W/B	V20	\$101.92

(1) Polyester and Teflon® sprinklers are suitable for decorative applications and are UL listed for corrosion resistance.  
(2) Teflon® sprinklers are also available with coated waterways without glass bulbs.

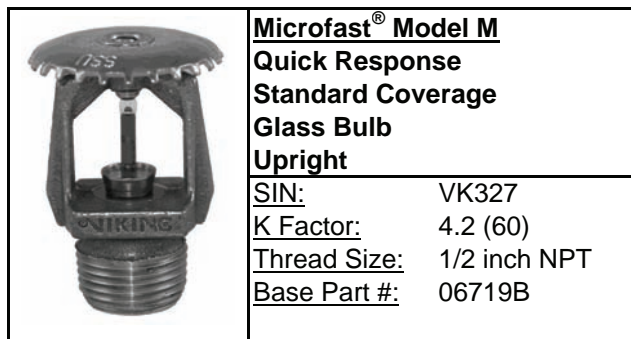

**Microfast® Model M**  
**Quick Response**  
**Standard Coverage**  
**Glass Bulb**  
**Upright**  
**SIN:** VK327  
**K Factor:** 4.2 (60)  
**Thread Size:** 1/2 inch NPT  
**Base Part #:** 06719B

Finish	Temp	Part #	IPG	List Price
Standard Brass	155°F	06719BAB	V14.2	\$37.15
Standard Brass	175°F	06719BAD	V14.2	\$37.15
Standard Brass	200°F	06719BAE	V14.2	\$37.15
Standard Brass	286°F	06719BAG	V14.2	\$37.15
Chrome	155°F	06719BFB	V14.2	\$39.82
Chrome	175°F	06719BFD	V14.2	\$39.82
Chrome	200°F	06719BFE	V14.2	\$39.82
Chrome	286°F	06719BFG	V14.2	\$39.82
White-Polyester <sup>1</sup>	155°F	06719BMB/W	V14.2	\$39.82
White-Polyester	175°F	06719BMD/W	V14.2	\$39.82
White-Polyester	200°F	06719BME/W	V14.2	\$39.82
White-Polyester	286°F	06719BMG/W	V14.2	\$39.82
Black-Polyester <sup>1</sup>	155°F	06719BMB/B	V20	\$40.98
Black-Polyester	175°F	06719BMD/B	V20	\$40.98
Black-Polyester	200°F	06719BME/B	V20	\$40.98
Black-Polyester	286°F	06719BMG/B	V20	\$40.98
Black-Teflon <sup>1,2</sup>	155°F	06719BNB	V20	\$49.82
Black-Teflon	175°F	06719BND	V20	\$49.82
Black-Teflon	200°F	06719BNE	V20	\$49.82
Black-Teflon	286°F	06719BNG	V20	\$49.82
Std Sprinkler Wrench		10896W/B	V20	\$49.85

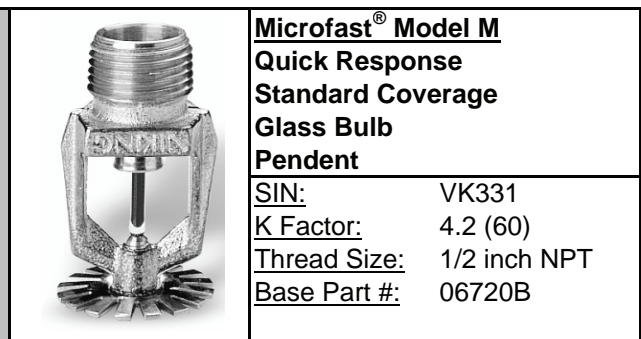

**Microfast® Model M**  
**Quick Response**  
**Standard Coverage**  
**Glass Bulb**  
**Pendent**  
**SIN:** VK331  
**K Factor:** 4.2 (60)  
**Thread Size:** 1/2 inch NPT  
**Base Part #:** 06720B

Finish	Temp	Part #	IPG	List Price
Standard Brass	155°F	06720BAB	V14.2	\$37.15
Standard Brass	175°F	06720BAD	V14.2	\$37.15
Standard Brass	200°F	06720BAE	V14.2	\$37.15
Standard Brass	286°F	06720BAG	V14.2	\$37.15
Chrome	155°F	06720BFB	V14.2	\$39.82
Chrome	175°F	06720BFD	V14.2	\$39.82
Chrome	200°F	06720BFE	V14.2	\$39.82
Chrome	286°F	06720BFG	V14.2	\$39.82
White-Polyester <sup>1</sup>	155°F	06720BMB/W	V14.2	\$39.82
White-Polyester	175°F	06720BMD/W	V14.2	\$39.82
White-Polyester	200°F	06720BME/W	V14.2	\$39.82
White-Polyester	286°F	06720BMG/W	V14.2	\$39.82
Black-Polyester <sup>1</sup>	155°F	06720BMB/B	V20	\$40.98
Black-Polyester	175°F	06720BMD/B	V20	\$40.98
Black-Polyester	200°F	06720BME/B	V20	\$40.98
Black-Polyester	286°F	06720BMG/B	V20	\$40.98
Black-Teflon <sup>1,2</sup>	155°F	06720BNB	V20	\$49.82
Black-Teflon	175°F	06720BND	V20	\$49.82
Black-Teflon	200°F	06720BNE	V20	\$49.82
Black-Teflon	286°F	06720BNG	V20	\$49.82
Std Sprinkler Wrench		10896W/B	V20	\$49.85
Wrench for Rcstd w/Caps		12144W/B	V20	\$101.92

(1) Polyester and Teflon® sprinklers are suitable for decorative applications and are UL listed for corrosion resistance.  
(2) Teflon® sprinklers are also available with coated waterways without glass bulbs.

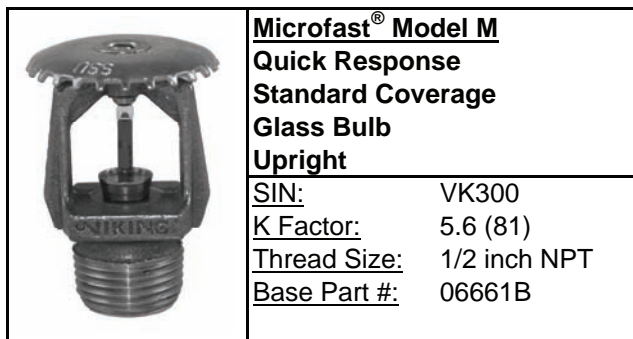

**Microfast® Model M**  
**Quick Response**  
**Standard Coverage**  
**Glass Bulb**  
**Upright**

**SIN:** VK300  
**K Factor:** 5.6 (81)  
**Thread Size:** 1/2 inch NPT  
**Base Part #:** 06661B

Finish	Temp	Part #	IPG	List Price
Standard Brass	135°F	06661BAA	V13	\$31.14
Standard Brass	155°F	06661BAB	V13	\$31.14
Standard Brass	175°F	06661BAD	V13	\$31.14
Standard Brass	200°F	06661BAE	V13	\$31.14
Standard Brass	286°F	06661BAG	V13	\$31.14
Chrome	135°F	06661BFA	V13.1	\$33.68
Chrome	155°F	06661BFB	V13.1	\$33.68
Chrome	175°F	06661BFD	V13.1	\$33.68
Chrome	200°F	06661BFE	V13.1	\$33.68
Chrome	286°F	06661BFG	V13.1	\$33.68
White-Polyester <sup>1</sup>	135°F	06661BMA/W	V13.2	\$33.68
White-Polyester	155°F	06661BMB/W	V13.2	\$33.68
White-Polyester	175°F	06661BMD/W	V13.2	\$33.68
White-Polyester	200°F	06661BME/W	V13.2	\$33.68
White-Polyester	286°F	06661BMG/W	V13.2	\$33.68
Black-Polyester <sup>1</sup>	135°F	06661BMA/B	V20	\$34.66
Black-Polyester	155°F	06661BMB/B	V20	\$34.66
Black-Polyester	175°F	06661BMD/B	V20	\$34.66
Black-Polyester	200°F	06661BME/B	V20	\$34.66
Black-Polyester	286°F	06661BMG/B	V20	\$34.66
Black-Teflon <sup>1,2</sup>	135°F	06661BNA	V20	\$44.71
Black-Teflon	155°F	06661BNB	V20	\$44.71
Black-Teflon	175°F	06661BND	V20	\$44.71
Black-Teflon	200°F	06661BNE	V20	\$44.71
Black-Teflon	286°F	06661BNG	V20	\$44.71
Std Sprinkler Wrench		10896W/B	V20	\$49.85

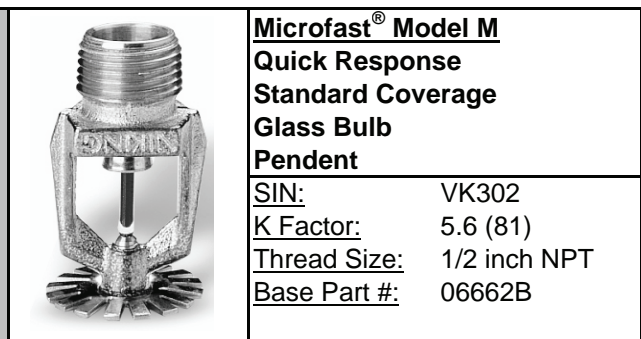

**Microfast® Model M**  
**Quick Response**  
**Standard Coverage**  
**Glass Bulb**  
**Pendant**

**SIN:** VK302  
**K Factor:** 5.6 (81)  
**Thread Size:** 1/2 inch NPT  
**Base Part #:** 06662B

Finish	Temp	Part #	IPG	List Price
Standard Brass	135°F	06662BAA	V13	\$31.14
Standard Brass	155°F	06662BAB	V13	\$31.14
Standard Brass	175°F	06662BAD	V13	\$31.14
Standard Brass	200°F	06662BAE	V13	\$31.14
Standard Brass	286°F	06662BAG	V13	\$31.14
Chrome	135°F	06662BFA	V13.1	\$33.68
Chrome	155°F	06662BFB	V13.1	\$33.68
Chrome	175°F	06662BFD	V13.1	\$33.68
Chrome	200°F	06662BFE	V13.1	\$33.68
Chrome	286°F	06662BFG	V13.1	\$33.68
White-Polyester <sup>1</sup>	135°F	06662BMA/W	V13.2	\$33.68
White-Polyester	155°F	06662BMB/W	V13.2	\$33.68
White-Polyester	175°F	06662BMD/W	V13.2	\$33.68
White-Polyester	200°F	06662BME/W	V13.2	\$33.68
White-Polyester	286°F	06662BMG/W	V13.2	\$33.68
Black-Polyester <sup>1</sup>	135°F	06662BMA/B	V20	\$34.66
Black-Polyester	155°F	06662BMB/B	V20	\$34.66
Black-Polyester	175°F	06662BMD/B	V20	\$34.66
Black-Polyester	200°F	06662BME/B	V20	\$34.66
Black-Polyester	286°F	06662BMG/B	V20	\$34.66
Black-Teflon <sup>1,2</sup>	135°F	06662BNA	V20	\$44.71
Black-Teflon	155°F	06662BNB	V20	\$44.71
Black-Teflon	175°F	06662BND	V20	\$44.71
Black-Teflon	200°F	06662BNE	V20	\$44.71
Black-Teflon	286°F	06662BNG	V20	\$44.71
Std Sprinkler Wrench		10896W/B	V20	\$49.85
Wrench for Rcstd w/Caps		12144W/B	V20	\$101.92

(1) Polyester and Teflon® sprinklers are suitable for decorative applications and are UL listed for corrosion resistance.

(2) Teflon® sprinklers are also available with coated waterways without glass bulbs.

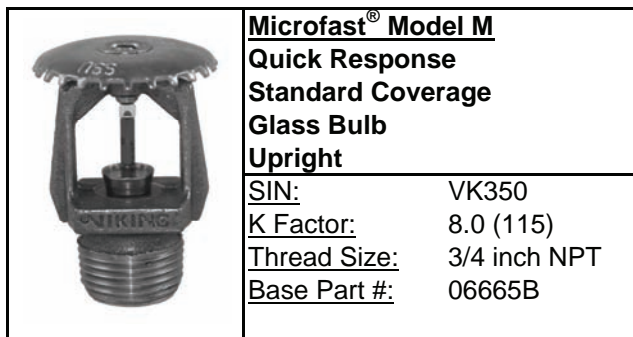

**Microfast® Model M**  
**Quick Response**  
**Standard Coverage**  
**Glass Bulb**  
**Upright**

**SIN:** VK350  
**K Factor:** 8.0 (115)  
**Thread Size:** 3/4 inch NPT  
**Base Part #:** 06665B

Finish	Temp	Part #	IPG	List Price
Standard Brass	155°F	06665BAB	V14	\$33.38
Standard Brass	175°F	06665BAD	V14	\$33.38
Standard Brass	200°F	06665BAE	V14	\$33.38
Standard Brass	286°F	06665BAG	V14	\$33.38
Chrome	155°F	06665BFB	V14	\$36.32
Chrome	175°F	06665BFD	V14	\$36.32
Chrome	200°F	06665BFE	V14	\$36.32
Chrome	286°F	06665BFG	V14	\$36.32
White-Polyester <sup>1</sup>	155°F	06665BMB/W	V14	\$36.32
White-Polyester	175°F	06665BMD/W	V14	\$36.32
White-Polyester	200°F	06665BME/W	V14	\$36.32
White-Polyester	286°F	06665BMG/W	V14	\$36.32
Black-Polyester <sup>1</sup>	155°F	06665BMB/B	V20	\$37.38
Black-Polyester	175°F	06665BMD/B	V20	\$37.38
Black-Polyester	200°F	06665BME/B	V20	\$37.38
Black-Polyester	286°F	06665BMG/B	V20	\$37.38
Black-Teflon <sup>1,2</sup>	155°F	06665BNB	V20	\$47.68
Black-Teflon	175°F	06665BND	V20	\$47.68
Black-Teflon	200°F	06665BNE	V20	\$47.68
Black-Teflon	286°F	06665BNG	V20	\$47.68
Std Sprinkler Wrench		10896W/B	V20	\$49.85

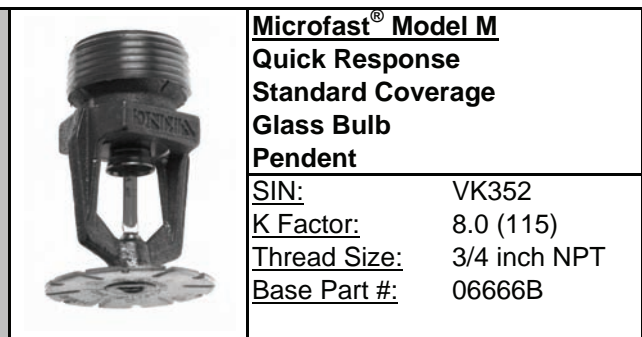

**Microfast® Model M**  
**Quick Response**  
**Standard Coverage**  
**Glass Bulb**  
**Pendent**

**SIN:** VK352  
**K Factor:** 8.0 (115)  
**Thread Size:** 3/4 inch NPT  
**Base Part #:** 06666B

Finish	Temp	Part #	IPG	List Price
Standard Brass	155°F	06666BAB	V14	\$33.38
Standard Brass	175°F	06666BAD	V14	\$33.38
Standard Brass	200°F	06666BAE	V14	\$33.38
Standard Brass	286°F	06666BAG	V14	\$33.38
Chrome	155°F	06666BFB	V14	\$36.32
Chrome	175°F	06666BFD	V14	\$36.32
Chrome	200°F	06666BFE	V14	\$36.32
Chrome	286°F	06666BFG	V14	\$36.32
White-Polyester <sup>1</sup>	155°F	06666BMB/W	V14	\$36.32
White-Polyester	175°F	06666BMD/W	V14	\$36.32
White-Polyester	200°F	06666BME/W	V14	\$36.32
White-Polyester	286°F	06666BMG/W	V14	\$36.32
Black-Polyester <sup>1</sup>	155°F	06666BMB/B	V20	\$37.38
Black-Polyester	175°F	06666BMD/B	V20	\$37.38
Black-Polyester	200°F	06666BME/B	V20	\$37.38
Black-Polyester	286°F	06666BMG/B	V20	\$37.38
Black-Teflon <sup>1,2</sup>	155°F	06666BNB	V20	\$47.68
Black-Teflon	175°F	06666BND	V20	\$47.68
Black-Teflon	200°F	06666BNE	V20	\$47.68
Black-Teflon	286°F	06666BNG	V20	\$47.68
Std Sprinkler Wrench		10896W/B	V20	\$49.85
Wrench for Rcsd w/Caps		12144W/B	V20	\$101.92

(1) Polyester and Teflon® sprinklers are suitable for decorative applications and are UL listed for corrosion resistance.

(2) Teflon® sprinklers are also available with coated waterways without glass bulbs.

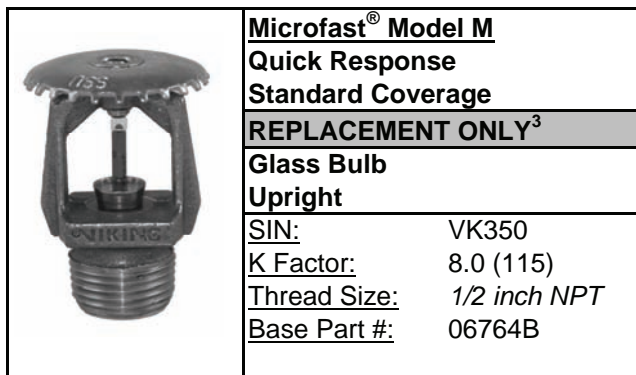

**Microfast® Model M**  
**Quick Response**  
**Standard Coverage**  
**REPLACEMENT ONLY<sup>3</sup>**  
**Glass Bulb**  
**Upright**  
**SIN:** VK350  
**K Factor:** 8.0 (115)  
**Thread Size:** 1/2 inch NPT  
**Base Part #:** 06764B

Finish	Temp	Part #	IPG	List Price
Standard Brass	155°F	06764BAB	V20	\$35.35
Standard Brass	175°F	06764BAD	V20	\$35.35
Standard Brass	200°F	06764BAE	V20	\$35.35
Standard Brass	286°F	06764BAG	V20	\$35.35
Chrome	155°F	06764BFB	V20	\$38.53
Chrome	175°F	06764BFD	V20	\$38.53
Chrome	200°F	06764BFE	V20	\$38.53
Chrome	286°F	06764BFG	V20	\$38.53
White-Polyester <sup>1</sup>	155°F	06764BMB/W	V20	\$38.53
White-Polyester	175°F	06764BMD/W	V20	\$38.53
White-Polyester	200°F	06764BME/W	V20	\$38.53
White-Polyester	286°F	06764BMG/W	V20	\$38.53
Black-Polyester <sup>1</sup>	155°F	06764BMB/B	V20	\$38.53
Black-Polyester	175°F	06764BMD/B	V20	\$38.53
Black-Polyester	200°F	06764BME/B	V20	\$38.53
Black-Polyester	286°F	06764BMG/B	V20	\$38.53
Black-Teflon <sup>1,2</sup>	155°F	06764BNB	V20	\$47.68
Black-Teflon	175°F	06764BND	V20	\$47.68
Black-Teflon	200°F	06764BNE	V20	\$47.68
Black-Teflon	286°F	06764BNG	V20	\$47.68
Std Sprinkler Wrench		10896W/B	V20	\$49.85

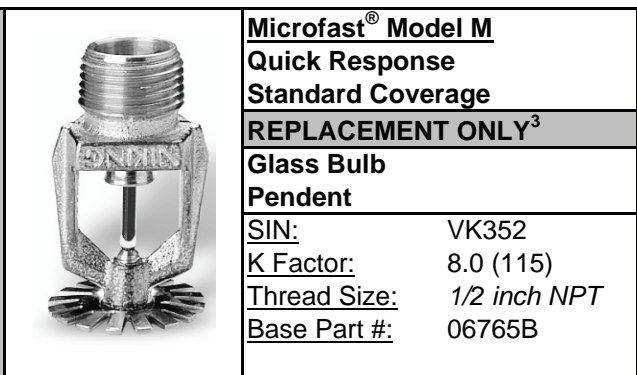

**Microfast® Model M**  
**Quick Response**  
**Standard Coverage**  
**REPLACEMENT ONLY<sup>3</sup>**  
**Glass Bulb**  
**Pendent**  
**SIN:** VK352  
**K Factor:** 8.0 (115)  
**Thread Size:** 1/2 inch NPT  
**Base Part #:** 06765B

Finish	Temp	Part #	IPG	List Price
Standard Brass	155°F	06765BAB	V20	\$35.35
Standard Brass	175°F	06765BAD	V20	\$35.35
Standard Brass	200°F	06765BAE	V20	\$35.35
Standard Brass	286°F	06765BAG	V20	\$35.35
Chrome	155°F	06765BFB	V20	\$38.53
Chrome	175°F	06765BFD	V20	\$38.53
Chrome	200°F	06765BFE	V20	\$38.53
Chrome	286°F	06765BFG	V20	\$38.53
White-Polyester <sup>1</sup>	155°F	06765BMB/W	V20	\$38.53
White-Polyester	175°F	06765BMD/W	V20	\$38.53
White-Polyester	200°F	06765BME/W	V20	\$38.53
White-Polyester	286°F	06765BMG/W	V20	\$38.53
Black-Polyester <sup>1</sup>	155°F	06765BMB/B	V20	\$38.53
Black-Polyester	175°F	06765BMD/B	V20	\$38.53
Black-Polyester	200°F	06765BME/B	V20	\$38.53
Black-Polyester	286°F	06765BMG/B	V20	\$38.53
Black-Teflon <sup>1,2</sup>	155°F	06765BNB	V20	\$47.68
Black-Teflon	175°F	06765BND	V20	\$47.68
Black-Teflon	200°F	06765BNE	V20	\$47.68
Black-Teflon	286°F	06765BNG	V20	\$47.68
Std Sprinkler Wrench		10896W/B	V20	\$49.85
Wrench for Rcstd w/Caps		12144W/B	V20	\$101.92

- (1) Polyester and Teflon® sprinklers are suitable for decorative applications and are UL listed for corrosion resistance.
- (2) Teflon® sprinklers are also available with coated waterways without glass bulbs.
- (3) Replacement only - Not allowed in new installations.

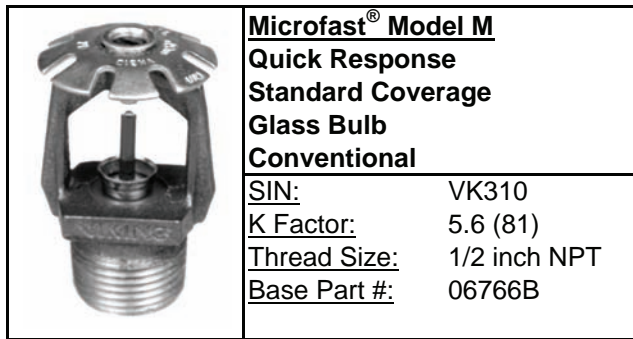

**Microfast® Model M**  
**Quick Response**  
**Standard Coverage**  
**Glass Bulb**  
**Conventional**  
SIN: VK310  
K Factor: 5.6 (81)  
Thread Size: 1/2 inch NPT  
Base Part #: 06766B

Finish	Temp	Part #	IPG	List Price
Standard Brass	155°F	06766BAB	V13	\$32.31
Standard Brass	175°F	06766BAD	V13	\$32.31
Standard Brass	200°F	06766BAE	V13	\$32.31
Standard Brass	286°F	06766BAG	V13	\$32.31
Chrome	155°F	06766BFB	V13.1	\$34.95
Chrome	175°F	06766BFD	V13.1	\$34.95
Chrome	200°F	06766BFE	V13.1	\$34.95
Chrome	286°F	06766BFG	V13.1	\$34.95
White-Polyester <sup>1</sup>	155°F	06766BMB/W	V13.2	\$34.95
White-Polyester	175°F	06766BMD/W	V13.2	\$34.95
White-Polyester	200°F	06766BME/W	V13.2	\$34.95
White-Polyester	286°F	06766BMG/W	V13.2	\$34.95
Black-Polyester <sup>1</sup>	155°F	06766BMB/B	V20	\$35.97
Black-Polyester	175°F	06766BMD/B	V20	\$35.97
Black-Polyester	200°F	06766BME/B	V20	\$35.97
Black-Polyester	286°F	06766BMG/B	V20	\$35.97
Black-Teflon <sup>1,2</sup>	155°F	06766BNB	V20	\$46.39
Black-Teflon	175°F	06766BND	V20	\$46.39
Black-Teflon	200°F	06766BNE	V20	\$46.39
Black-Teflon	286°F	06766BNG	V20	\$46.39
Std Sprinkler Wrench		10896W/B	V20	\$49.85

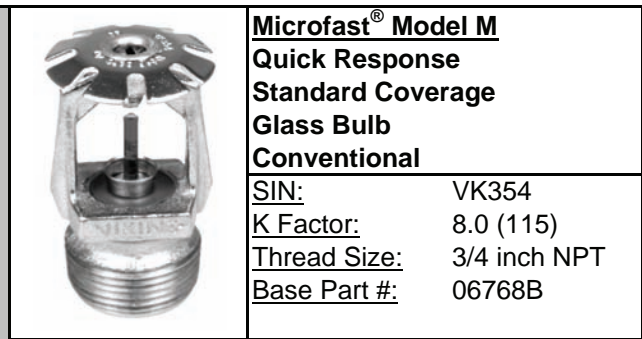

**Microfast® Model M**  
**Quick Response**  
**Standard Coverage**  
**Glass Bulb**  
**Conventional**  
SIN: VK354  
K Factor: 8.0 (115)  
Thread Size: 3/4 inch NPT  
Base Part #: 06768B

Finish	Temp	Part #	IPG	List Price
Standard Brass	155°F	06768BAB	V14	\$34.64
Standard Brass	175°F	06768BAD	V14	\$34.64
Standard Brass	200°F	06768BAE	V14	\$34.64
Standard Brass	286°F	06768BAG	V14	\$34.64
Chrome	155°F	06768BFB	V14	\$37.70
Chrome	175°F	06768BFD	V14	\$37.70
Chrome	200°F	06768BFE	V14	\$37.70
Chrome	286°F	06768BFG	V14	\$37.70
White-Polyester <sup>1</sup>	155°F	06768BMB/W	V14	\$37.70
White-Polyester	175°F	06768BMD/W	V14	\$37.70
White-Polyester	200°F	06768BME/W	V14	\$37.70
White-Polyester	286°F	06768BMG/W	V14	\$37.70
Black-Polyester <sup>1</sup>	155°F	06768BMB/B	V20	\$38.79
Black-Polyester	175°F	06768BMD/B	V20	\$38.79
Black-Polyester	200°F	06768BME/B	V20	\$38.79
Black-Polyester	286°F	06768BMG/B	V20	\$38.79
Black-Teflon <sup>1,2</sup>	155°F	06768BNB	V20	\$49.48
Black-Teflon	175°F	06768BND	V20	\$49.48
Black-Teflon	200°F	06768BNE	V20	\$49.48
Black-Teflon	286°F	06768BNG	V20	\$49.48
Std Sprinkler Wrench		10896W/B	V20	\$49.85

(1) Polyester and Teflon® sprinklers are suitable for decorative applications and are UL listed for corrosion resistance.  
(2) Teflon® sprinklers are also available with coated waterways without glass bulbs.

<b>Microfast® Model M</b> <b>Quick Response</b> <b>Standard Coverage</b> <b>Glass Bulb</b> <b>Horizontal Sidewall</b>					<b>Microfast® Model M</b> <b>Quick Response</b> <b>Standard Coverage</b> <b>Glass Bulb</b> <b>Horizontal Sidewall</b>				
		<b>SIN:</b> VK333 <b>K Factor:</b> 2.8 (40) <b>Thread Size:</b> 1/2 inch NPT <b>Base Part #:</b> 10035					<b>SIN:</b> VK304 <b>K Factor:</b> 5.6 (81) <b>Thread Size:</b> 1/2 inch NPT <b>Base Part #:</b> 06725B		
Finish	Temp	Part #	IPG	List Price	Finish	Temp	Part #	IPG	List Price
Standard Brass	155°F	10035AB	V20	\$40.16	Standard Brass	155°F	06725BAB	V13	\$35.80
Standard Brass	175°F	10035AD	V20	\$40.16	Standard Brass	175°F	06725BAD	V13	\$35.80
Standard Brass	200°F	10035AE	V20	\$40.16	Standard Brass	200°F	06725BAE	V13	\$35.80
Standard Brass	286°F	10035AG	V20	\$40.16	Standard Brass	286°F	06725BAG	V13	\$35.80
Chrome	155°F	10035FB	V20	\$42.59	Chrome	155°F	06725BFB	V13.1	\$38.52
Chrome	175°F	10035FD	V20	\$42.59	Chrome	175°F	06725BFD	V13.1	\$38.52
Chrome	200°F	10035FE	V20	\$42.59	Chrome	200°F	06725BFE	V13.1	\$38.52
Chrome	286°F	10035FG	V20	\$42.59	Chrome	286°F	06725BFG	V13.1	\$38.52
White-Polyester <sup>1</sup>	155°F	10035MB/W	V20	\$42.59	White-Polyester <sup>1</sup>	155°F	06725BMB/W	V13.2	\$38.52
White-Polyester	175°F	10035MD/W	V20	\$42.59	White-Polyester	175°F	06725BMD/W	V13.2	\$38.52
White-Polyester	200°F	10035ME/W	V20	\$42.59	White-Polyester	200°F	06725BME/W	V13.2	\$38.52
White-Polyester	286°F	10035MG/W	V20	\$42.59	White-Polyester	286°F	06725BMG/W	V13.2	\$38.52
Black-Polyester <sup>1</sup>	155°F	10035MB/B	V20	\$42.59	Black-Polyester <sup>1</sup>	155°F	06725BMB/B	V20	\$39.63
Black-Polyester	175°F	10035MD/B	V20	\$42.59	Black-Polyester	175°F	06725BMD/B	V20	\$39.63
Black-Polyester	200°F	10035ME/B	V20	\$42.59	Black-Polyester	200°F	06725BME/B	V20	\$39.63
Black-Polyester	286°F	10035MG/B	V20	\$42.59	Black-Polyester	286°F	06725BMG/B	V20	\$39.63
Black-Teflon <sup>1,2</sup>	155°F	10035NB	V20	\$55.75	Black-Teflon <sup>1,2</sup>	155°F	06725BNB	V20	\$48.78
Black-Teflon	175°F	10035ND	V20	\$55.75	Black-Teflon	175°F	06725BND	V20	\$48.78
Black-Teflon	200°F	10035NE	V20	\$55.75	Black-Teflon	200°F	06725BNE	V20	\$48.78
Black-Teflon	286°F	10035NG	V20	\$55.75	Black-Teflon	286°F	06725BNG	V20	\$48.78
Std Sprinkler Wrench		10896W/B	V20	\$49.85	Std Sprinkler Wrench		10896W/B	V20	\$49.85
Wrench for Rcsd w/Shld		13655W/B	V20	\$104.77	Wrench for Rcsd w/Shld		13655W/B	V20	\$104.77

(1) Polyester and Teflon® sprinklers are suitable for decorative applications and are UL listed for corrosion resistance.  
 (2) Teflon® sprinklers are also available with coated waterways without glass bulbs.

					<b>Microfast® Model M</b> <b>Quick Response</b> <b>Standard Coverage</b> <b>Glass Bulb</b> <b>Horizontal Sidewall</b>				
					SIN:		VK305 <sup>1</sup>		
K Factor:		5.6 (81)							
Thread Size:		1/2 inch NPT							
Base Part #:		12121							
Finish	Temp	Part #	IPG	List Price					
Standard Brass	155°F	12121AB	V13	\$35.81					
Standard Brass	175°F	12121AD	V13	\$35.81					
Standard Brass	200°F	12121AE	V13	\$35.81					
Standard Brass	286°F	12121AG	V13	\$35.81					
Chrome	155°F	12121FB	V13.1	\$38.52					
Chrome	175°F	12121FD	V13.1	\$38.52					
Chrome	200°F	12121FE	V13.1	\$38.52					
Chrome	286°F	12121FG	V13.1	\$38.52					
White-Polyester <sup>3</sup>	155°F	12121MB/W	V13.2	\$38.52					
White-Polyester	175°F	12121MD/W	V13.2	\$38.52					
White-Polyester	200°F	12121ME/W	V13.2	\$38.52					
White-Polyester	286°F	12121MG/W	V13.2	\$38.52					
Black-Polyester <sup>3</sup>	155°F	12121MB/B	V20	\$39.63					
Black-Polyester	175°F	12121MD/B	V20	\$39.63					
Black-Polyester	200°F	12121ME/B	V20	\$39.63					
Black-Polyester	286°F	12121MG/B	V20	\$39.63					
Black-Teflon <sup>3,4</sup>	155°F	12121NB	V20	\$48.78					
Black-Teflon	175°F	12121ND	V20	\$48.78					
Black-Teflon	200°F	12121NE	V20	\$48.78					
Black-Teflon	286°F	12121NG	V20	\$48.78					
Std Sprinkler Wrench		10896W/B	V20	\$49.85					
Wrench for Rcstd w/Shld		13655W/B	V20	\$104.77					

					<b>Microfast® Model M</b> <b>Quick Response</b> <b>Standard Coverage</b> <b>Glass Bulb</b> <b>Horizontal Sidewall</b>				
					SIN:		VK360 <sup>1</sup>		
K Factor:		8.0 (115)							
Thread Size:		3/4 inch NPT							
Base Part #:		15591							
Finish	Temp	Part #	IPG	List Price					
Standard Brass	135°F	15591AA	V20.2	\$28.96					
Standard Brass	155°F	15591AB	V20.2	\$28.96					
Standard Brass	175°F	15591AD	V20.2	\$28.96					
Standard Brass	200°F	15591AE	V20.2	\$28.96					
Chrome	135°F	15591FA	V20.2	\$33.31					
Chrome	155°F	15591FB	V20.2	\$33.31					
Chrome	175°F	15591FD	V20.2	\$33.31					
Chrome	200°F	15591FE	V20.2	\$33.31					
White-Polyester <sup>3</sup>	135°F	15591MA/W	V20.2	\$33.31					
White-Polyester	155°F	15591MB/W	V20.2	\$33.31					
White-Polyester	175°F	15591MD/W	V20.2	\$33.31					
White-Polyester	200°F	15591ME/W	V20.2	\$33.31					
Black-Polyester <sup>3</sup>	135°F	15591MA/B	V20.2	\$33.31					
Black-Polyester	155°F	15591MB/B	V20.2	\$33.31					
Black-Polyester	175°F	15591MD/B	V20.2	\$33.31					
Black-Polyester	200°F	15591ME/B	V20.2	\$33.31					
Black-Teflon <sup>3,4</sup>	135°F	15591NA	V20.2	POA					
Black-Teflon	155°F	15591NB	V20.2	POA					
Black-Teflon	175°F	15591ND	V20.2	POA					
Black-Teflon	200°F	15591NE	V20.2	POA					
Std Sprinkler Wrench		10896W/B	V20	\$49.85					
Wrench for Rcstd w/Shld		13655W/B	V20	\$104.77					

					<b>Microfast® Model M</b> <b>Quick Response</b> <b>Standard Coverage</b> <b>Glass Bulb</b> <b>Vertical Sidewall</b>				
					SIN:		VK306 <sup>2</sup>		
K Factor:		5.6 (81)							
Thread Size:		1/2 inch NPT							
Base Part #:		06727B							

Finish	Temp	Part #	IPG	List Price
Standard Brass	155°F	06727BAB	V20	\$37.69
Standard Brass	175°F	06727BAD	V20	\$37.69
Standard Brass	200°F	06727BAE	V20	\$37.69
Standard Brass	286°F	06727BAG	V20	\$37.69
Chrome	155°F	06727BFB	V20	\$41.06
Chrome	175°F	06727BFD	V20	\$41.06
Chrome	200°F	06727BFE	V20	\$41.06
Chrome	286°F	06727BFG	V20	\$41.06
White-Polyester <sup>3</sup>	155°F	06727BMB/W	V20	\$41.06
White-Polyester	175°F	06727BMD/W	V20	\$41.06
White-Polyester	200°F	06727BME/W	V20	\$41.06
White-Polyester	286°F	06727BMG/W	V20	\$41.06
Black-Polyester <sup>3</sup>	155°F	06727BMB/B	V20	\$41.06
Black-Polyester	175°F	06727BMD/B	V20	\$41.06
Black-Polyester	200°F	06727BME/B	V20	\$41.06
Black-Polyester	286°F	06727BMG/B	V20	\$41.06
Black-Teflon <sup>3,4</sup>	155°F	06727BNB	V20	\$50.54
Black-Teflon	175°F	06727BND	V20	\$50.54
Black-Teflon	200°F	06727BNE	V20	\$50.54
Black-Teflon	286°F	06727BNG	V20	\$50.54
Std Sprinkler Wrench		10896W/B	V20	\$49.85

- (1) Light/Ordinary hazard
- (2) Light hazard only
- (3) Polyester and Teflon® sprinklers are suitable for decorative applications and are UL listed for corrosion resistance.
- (4) Teflon® sprinklers are also available with coated waterways without glass bulbs.



**Domed Concealed<sup>1</sup>**  
**Quick Response<sup>2</sup>**  
**Standard Coverage**  
**Glass Bulb**  
**Pendant**

SIN: VK302-D  
K Factor: 5.6 (81)  
Thread Size: 1/2 inch NPT  
Base Part #: 06662BA-X

Finish	Temp	Part #	IPG	List Price
Standard Brass	155°F	06662BABX	V15.4	\$31.31
Standard Brass	175°F	06662BADX	V15.4	\$31.31
Standard Brass	200°F	06662BAEX	V15.4	\$31.31
Spk Wrench Domed Cncd	13577W/B	V20		\$92.65



**Domed Concealed<sup>1</sup>**  
**Quick Response<sup>2</sup>**  
**Standard Coverage**  
**Glass Bulb**  
**Pendant**

SIN: VK352-D  
K Factor: 8.0 (115)  
Thread Size: 3/4 inch NPT  
Base Part #: 06666BA-X

Finish	Temp	Part #	IPG	List Price
Standard Brass	155°F	06666BABX	V15.4	\$44.04
Standard Brass	175°F	06666BADX	V15.4	\$44.04
Standard Brass	200°F	06666BAEX	V15.4	\$44.04
Spk Wrench Domed Cncd	13577W/B	V20		\$92.65

**Domed Cover Plate<sup>1</sup>**  
Base Part #: 12381

Finish	Temp	Part #	IPG	List Price
Chrome	135°F	12381FA	V15.3	\$22.82
Chrome	165°F	12381FC	V15.3	\$22.82
Painted White	135°F	12381MA/SW1004	V15.3	\$22.82
Painted White	165°F	12381MC/SW1004	V15.3	\$22.82
Painted Ivory	135°F	12381MA/SW1634	V15.3	\$28.60
Painted Ivory	165°F	12381MC/SW1634	V15.3	\$28.60
Painted Black	135°F	12381MA/SW1007	V15.3	\$28.60
Painted Black	165°F	12381MC/SW1007	V15.3	\$28.60
Bright Brass	135°F	12381BA/B	V15.3	\$28.60
Bright Brass	165°F	12381BC/B	V15.3	\$28.60





**Horizon® Flush (Model H-1)<sup>2</sup>**  
**Quick Response**  
**Standard Coverage**  
**Fusible Link**  
**Flush Pendant**

SIN: VK402  
K Factor: 5.6 (81)  
Thread Size: 1/2 inch NPT  
Base Part #: 06702B

Finish	Temp	Part #	IPG	List Price
Chrome	165°F	06702BFC	V17	\$53.65
Painted White	165°F	06702BMC/W	V17	\$54.55
Heavy Duty Spk Wrench	08336W/B	V20		\$96.00
Light Duty Spk Wrench	10366W/B	V20		\$22.73

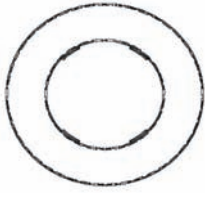
**Ceiling Rings<sup>2</sup>**



Outside Diameter = 2-11/16 inches				
Finish	Type	Part #	IPG	List Price
Chrome	Push	07027F	V17	\$5.36
Chrome	Thread	06919BF	V17	\$5.49
Painted White	Push	07027M/W	V17	\$5.65
Painted White	Thread	06919BM/W	V17	\$5.75
Outside Diameter = 3 in. (push on), 3-1/4 in. (thread on)				
Finish	Type	Part #	IPG	List Price
Chrome	Push	07626F	V17	\$5.49
Chrome	Thread	06905BF	V17	\$9.32
Painted White	Push	07626M/W	V17	\$5.75
Painted White	Thread	06905BM/W	V17	\$9.57

(1) Cover plates sold separately. Covers are also available in custom colors at an additional charge (see page F-8 for details).  
 (2) FM Approved as standard response. Refer to technical data page for complete listing and approval details.  
 (3) Ceiling rings for Horizon flush pendant sprinklers are sold separately.

	<b>Mirage®</b>			
	<b>Quick Response Standard Coverage Glass Bulb Concealed Pendant</b>			
	<u>SIN:</u>	VK461		
	<u>K Factor:</u>	2.8 (40)		
	<u>Thread Size:</u>	1/2 inch NPT		
<u>Base Part #:</u>	13831A			
<b>Finish</b>	<b>Temp</b>	<b>Part #</b>	<b>IPG</b>	<b>List Price</b>
Standard Brass	155°F	13831AB	V16.4	\$44.11
Standard Brass	175°F	13831AD	V16.4	\$44.11
Standard Brass	200°F	13831AE	V16.4	\$44.11

	<b>Mirage®</b>			
	<b>Quick Response Standard Coverage Glass Bulb Concealed Pendant</b>			
	<u>SIN:</u>	VK465		
	<u>K Factor:</u>	4.2 (60)		
	<u>Thread Size:</u>	1/2 inch NPT		
<u>Base Part #:</u>	14262A			
<b>Finish</b>	<b>Temp</b>	<b>Part #</b>	<b>IPG</b>	<b>List Price</b>
Standard Brass	155°F	14262AB	V16.4	\$44.11
Standard Brass	175°F	14262AD	V16.4	\$44.11
Standard Brass	200°F	14262AE	V16.4	\$44.11

**COVER PLATES AND WRENCHES ARE SOLD SEPARATELY - SEE PAGE B-11 AND B-12 FOR DETAILS**

	<b>Mirage®</b>			
	<b>Quick Response Standard Coverage Glass Bulb Concealed Pendant</b>			
	<u>SIN:</u>	VK462		
	<u>K Factor:</u>	5.6 (81)		
	<u>Thread Size:</u>	1/2 inch NPT		
<u>Base Part #:</u>	13503A			
<b>Finish</b>	<b>Temp</b>	<b>Part #</b>	<b>IPG</b>	<b>List Price</b>
Standard Brass	155°F	13503AB	V16.4	\$35.56
Standard Brass	175°F	13503AD	V16.4	\$35.56
Standard Brass	200°F	13503AE	V16.4	\$35.56

	<b>Mirage® - HIGH PRESSURE</b>			
	<b>Quick Response Standard Coverage Glass Bulb Concealed Pendant</b>			
	<u>SIN:</u>	VK463		
	<u>K Factor:</u>	5.6 (81) - <b>HP</b>		
	<u>Thread Size:</u>	1/2 inch NPT		
<u>Base Part #:</u>	13667A			
<b>Finish</b>	<b>Temp</b>	<b>Part #</b>	<b>IPG</b>	<b>List Price</b>
Standard Brass	155°F	13667AB	V16.4	\$40.86
Standard Brass	175°F	13667AD	V16.4	\$40.86
Standard Brass	200°F	13667AE	V16.4	\$40.86

**COVER PLATES AND WRENCHES ARE SOLD SEPARATELY - SEE PAGE B-11 AND B-12 FOR DETAILS**

	<b>Mirage®</b>			
	<b>Quick Response Standard Coverage Glass Bulb Concealed Pendant</b>			
	<u>SIN:</u>	VK464		
	<u>K Factor:</u>	8.0 (115)		
	<u>Thread Size:</u>	3/4 inch NPT		
<u>Base Part #:</u>	13614A			
<b>Finish</b>	<b>Temp</b>	<b>Part #</b>	<b>IPG</b>	<b>List Price</b>
Standard Brass	155°F	13614AB	V16.4	\$52.19
Standard Brass	175°F	13614AD	V16.4	\$52.19
Standard Brass	200°F	13614AE	V16.4	\$52.19

	<b>ELO Mirage®<sup>1</sup></b>			
	<b>Quick Response Standard Coverage Fusible Link Concealed Pendant</b>			
	<u>SIN:</u>	VK469		
	<u>K Factor:</u>	11.2 (161)		
	<u>Thread Size:</u>	3/4 inch NPT		
<u>Base Part #:</u>	15764A			
<b>Finish</b>	<b>Temp</b>	<b>Part #</b>	<b>IPG</b>	<b>List Price</b>
Standard Brass	165°F	15764AC	V16.4	\$51.90
Standard Brass	205°F	15764AE	V16.4	\$51.90

(1) Use only cover plate 15765 with VK469 (see page C-11)

**COVER PLATES AND WRENCHES ARE SOLD SEPARATELY - SEE PAGE B-11 AND B-12 FOR DETAILS**

	<b>Mirage MRI Room Sprinkler*</b>			
	<b>Quick Response Standard Coverage Glass Bulb Concealed Pendant</b>			
	<u>SIN:</u>	VK462-MRI		
	<u>K Factor:</u>	5.6 (81)		
	<u>Thread Size:</u>	1/2 inch NPT		
<u>Base Part #:</u>	15480A			
<b>Finish</b>	<b>Temp</b>	<b>Part #</b>	<b>IPG</b>	<b>List Price</b>
Standard Brass	155°F	15480AB	TBD	\$109.84
Standard Brass	175°F	15480AD	TBD	\$109.84
Standard Brass	200°F	15480AE	TBD	\$109.84

	<b>Mirage MRI Room Sprinkler*</b>			
	<b>Quick Response Standard Coverage Glass Bulb Concealed Pendant</b>			
	<u>SIN:</u>	VK464-MRI		
	<u>K Factor:</u>	8.0 (115)		
	<u>Thread Size:</u>	3/4 inch NPT		
<u>Base Part #:</u>	15481A			
<b>Finish</b>	<b>Temp</b>	<b>Part #</b>	<b>IPG</b>	<b>List Price</b>
Standard Brass	155°F	15481AB	TBD	\$122.24
Standard Brass	175°F	15481AD	TBD	\$122.24
Standard Brass	200°F	15481AE	TBD	\$122.24

\* Non-ferrous - for use in a high magnetic field environment, such as an MRI room

**COVER PLATES AND WRENCHES ARE SOLD SEPARATELY - SEE PAGE B-11 AND B-12 FOR DETAILS**

<b>Standard Cover Plate</b>				
<i>Diameter = 2-3/4 inches</i>				
<i>Use w/ VK461, 462, 463, 464, 465</i>				
Finish	Temp	Part #	IPG	List
Polished Chrome	135°F	13504FA	V16.2	\$22.99
Polished Chrome	165°F	13504FC	V16.2	\$22.99
White	135°F	13504MA/SW1004	V16.2	\$22.99
White	165°F	13504MC/SW1004	V16.2	\$22.99
Ivory	135°F	13504MA/SW1634	V16.2	\$28.77
Ivory	165°F	13504MC/SW1634	V16.2	\$28.77
Black	135°F	13504MA/SW1007	V16.2	\$28.77
Black	165°F	13504MC/SW1007	V16.2	\$28.77
Bright Brass	135°F	13504BA	V16.2	\$28.77
Bright Brass	165°F	13504BC	V16.2	\$28.77
Brushed Brass	135°F	13504BA/B	V16.2	\$28.77
Brushed Brass	165°F	13504BC/B	V16.2	\$28.77
Antique Brass	135°F	13504BA/A	V16.2	\$28.77
Antique Brass	165°F	13504BC/A	V16.2	\$28.77
Brushed Copper	135°F	13504EA/B	V16.2	\$28.77
Brushed Copper	165°F	13504EC/B	V16.2	\$28.77
Brushed Chrome	135°F	13504FA/B	V16.2	\$28.77
Brushed Chrome	165°F	13504FC/B	V16.2	\$28.77



<b>Large Cover Plate</b>				
<i>Diameter = 3-5/16 inches</i>				
<i>Use w/ VK461, 462, 463, 464, 465</i>				
Finish	Temp	Part #	IPG	List
Polished Chrome	135°F	13642FA	V16.2	\$22.99
Polished Chrome	165°F	13642FC	V16.2	\$22.99
White	135°F	13642MA/SW1004	V16.2	\$22.99
White	165°F	13642MC/SW1004	V16.2	\$22.99
Ivory	135°F	13642MA/SW1634	V16.2	\$28.77
Ivory	165°F	13642MC/SW1634	V16.2	\$28.77
Black	135°F	13642MA/SW1007	V16.2	\$28.77
Black	165°F	13642MC/SW1007	V16.2	\$28.77
Bright Brass	135°F	13642BA	V16.2	\$28.77
Bright Brass	165°F	13642BC	V16.2	\$28.77
Brushed Brass	135°F	13642BA/B	V16.2	\$28.77
Brushed Brass	165°F	13642BC/B	V16.2	\$28.77
Antique Brass	135°F	13642BA/A	V16.2	\$28.77
Antique Brass	165°F	13642BC/A	V16.2	\$28.77
Brushed Copper	135°F	13642EA/B	V16.2	\$28.77
Brushed Copper	165°F	13642EC/B	V16.2	\$28.77
Brushed Chrome	135°F	13642FA/B	V16.2	\$28.77
Brushed Chrome	165°F	13642FC/B	V16.2	\$28.77



<b>Square Cover Plate</b>				
<i>Use w/ VK461, 462, 463, 464, 465</i>				
Finish	Temp	Part #	IPG	List
Polished Chrome	135°F	15394FA	V16.5	\$39.56
Polished Chrome	165°F	15394FC	V16.5	\$39.56
White	135°F	15394MA/SW1004	V16.5	\$37.96
White	165°F	15394MC/SW1004	V16.5	\$37.96
Ivory	135°F	15394MA/SW1634	V16.5	\$37.96
Ivory	165°F	15394MC/SW1634	V16.5	\$37.96
Black	135°F	15394MA/SW1007	V16.5	\$37.96
Black	165°F	15394MC/SW1007	V16.5	\$37.96
Bright Brass	135°F	15394BA	V16.5	\$46.30
Bright Brass	165°F	15394BC	V16.5	\$46.30
Brushed Brass	135°F	15394BA/B	V16.5	\$46.30
Brushed Brass	165°F	15394BC/B	V16.5	\$46.30
Antique Brass	135°F	15394BA/A	V16.5	\$46.30
Antique Brass	165°F	15394BC/A	V16.5	\$46.30
Brushed Copper	135°F	15394EA/B	V16.5	\$46.30
Brushed Copper	165°F	15394EC/B	V16.5	\$46.30
Brushed Chrome	135°F	15394FA/B	V16.5	\$46.30
Brushed Chrome	165°F	15394FC/B	V16.5	\$46.30



<b>Mirage ELO Cover Plate</b>				
<i>Diameter = 3-5/16 inches</i>				
<i>* For use with VK469 ELO only</i>				
Finish	Temp	Part #	IPG	List
Polished Chrome	135°F	15765FA	V16.2	\$22.99
Polished Chrome	165°F	15765FC	V16.2	\$22.99
White	135°F	15765MA/SW1004	V16.2	\$22.99
White	165°F	15765MC/SW1004	V16.2	\$22.99
Ivory	135°F	15765MA/SW1634	V16.2	\$28.77
Ivory	165°F	15765MC/SW1634	V16.2	\$28.77
Black	135°F	15765MA/SW1007	V16.2	\$28.77
Black	165°F	15765MC/SW1007	V16.2	\$28.77



<b>Cleanroom Cover Assembly</b>	
<i>Diameter = 3-5/16 inches</i>	
<i>cULus listed</i>	
<i>For use w/ VK461, 462, 463, 464, 465</i>	
<i>Gasket color is white</i>	
<ul style="list-style-type: none"> <li>• Provides seal for cleanroom and clean zone environments</li> <li>• VK462 retains QR listing with cleanroom cover plate installed</li> <li>• Cover plate available in 135°F and 165°F temperature rating</li> <li>• Also listed for use with Mirage-MRI room sprinkler (non-ferrous)</li> </ul>	



Finish	Temp	Part #	IPG	List
Polished Chrome	135°F	13642FA/CR	V16.2	\$59.87
Polished Chrome	165°F	13642FC/CR	V16.2	\$59.87
White	135°F	13642MA/SW1004/CR	V16.2	\$59.87
White	165°F	13642MC/SW1004/CR	V16.2	\$59.87
Ivory	135°F	13642MA/SW1634/CR	V16.2	\$59.87
Ivory	165°F	13642MC/SW1634/CR	V16.2	\$59.87
Black	135°F	13642MA/SW1007/CR	V16.2	\$59.87
Black	165°F	13642MC/SW1007/CR	V16.2	\$59.87

	<b>Mirage® Adjustable Concealed Pendant</b> <b>Quick Response</b> <b>Standard Coverage</b> <b>Glass Bulb</b> <b>Adjustable Concealed Pendant</b>		<b>Offers 1-1/2 inch (38 mm) of total vertical adjustment</b>
	<b>SINs:</b> VK461, VK465, VK462		
	<b>K Factors:</b> 2.8 (40), 4.2 (61), and 5.6 (81)		
	<b>Thread Size:</b> 1 inch NPT (male and female connections)		

Finish	Connection	K factor	Temp	Part #	IPG	List Price
<b>VK461, 2.8 (40) K factor, Adjustable Concealed Pendant</b>						
Standard Brass	Male	2.8 (40)	155°F	14927AB	V15.4	\$134.08
Standard Brass	Male	2.8 (40)	175°F	14927AD	V15.4	\$134.08
Standard Brass	Male	2.8 (40)	200°F	14927AE	V15.4	\$134.08
Standard Brass	Female	2.8 (40)	155°F	14928AB	V15.4	\$134.08
Standard Brass	Female	2.8 (40)	175°F	14928AD	V15.4	\$134.08
Standard Brass	Female	2.8 (40)	200°F	14928AE	V15.4	\$134.08
<b>VK465, 4.2 (61) K factor, Adjustable Concealed Pendant</b>						
Standard Brass	Male	4.2 (61)	155°F	14929AB	V15.4	\$134.08
Standard Brass	Male	4.2 (61)	175°F	14929AD	V15.4	\$134.08
Standard Brass	Male	4.2 (61)	200°F	14929AE	V15.4	\$134.08
Standard Brass	Female	4.2 (61)	155°F	14930AB	V15.4	\$134.08
Standard Brass	Female	4.2 (61)	175°F	14930AD	V15.4	\$134.08
Standard Brass	Female	4.2 (61)	200°F	14930AE	V15.4	\$134.08
<b>VK462, 5.6 (81) K factor, Adjustable Concealed Pendant</b>						
Standard Brass	Male	5.6 (81)	155°F	14918AB	V15.4	\$134.08
Standard Brass	Male	5.6 (81)	175°F	14918AD	V15.4	\$134.08
Standard Brass	Male	5.6 (81)	200°F	14918AE	V15.4	\$134.08
Standard Brass	Female	5.6 (81)	155°F	14919AB	V15.4	\$134.08
Standard Brass	Female	5.6 (81)	175°F	14919AD	V15.4	\$134.08
Standard Brass	Female	5.6 (81)	200°F	14919AE	V15.4	\$134.08

**COVER PLATES SOLD SEPARATELY - See page B-11 for available cover plate options**

**Mirage® Concealed Pendant Sprinklers - Wrenches and Special Installation Tools**

**Standard / Heavy Duty Wrench**  
(use with all Mirage sprinklers except VK469 ELO)

Part #	List Price
14047W/B	\$96.01

\* item price group V20

**VK469 - Standard / Heavy Duty Wrench**  
(use only with VK469 Mirage ELO sprinkler)

Part #	List Price
15467W/B	\$96.01

\* item price group V20

**Cabinet Wrench and Protective Cap Removal Tool**

	Standard	VK469 ELO
	14031	15466
	\$19.67	\$19.67

\* item price group V20

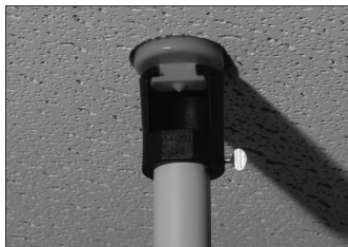

Figure 1: Attach Sprinkler Wrench 14031 onto a length of 1" diameter CPVC pipe



Figure 2: Use Sprinkler Wrench 14031 to remove the protective sprinkler cap.

**Cover Plate Installation Tool - Standard Dia. Cover Plates**

	14412
	\$8.69

\* item price group V20



Figure 3: Attach the Cover Installer Tool onto the end of CPVC pipe.



Figure 4: Use the Cover Installer Tool to install the Mirage® Concealed Cover Plate.



Figure 5: Correct use of the Cover Installer Tool

**Cover Plate Installation Tool - Large Dia. Cover Plates**

	14867
	\$8.69

\* item price group V20

	<b>Quick Response Standard Coverage Fusible Link Concealed Sidewall</b>			
	<b>SIN:</b>	VK408		
<b>K Factor:</b>	5.6 (81)			
<b>Thread Size:</b>	1/2 inch NPT			
<b>Base Part #:</b>	11262A			
<b>Finish</b>	<b>Temp</b>	<b>Part #</b>	<b>IPG</b>	<b>List Price</b>
Standard Brass	165°F	11262AC	V16.3	\$48.18
Heavy Duty Spk Wrench		08336W/B	V20	\$96.00
Light Duty Spk Wrench		10366W/B	V20	\$22.73

cover plate sold separately (see below)

<b>Cover Plate<sup>1</sup></b>				
<b>Base Part #:</b>		11451		
<b>Finish</b>	<b>Temp</b>	<b>Part #</b>	<b>IPG</b>	<b>List Price</b>
Polished Chrome	135°F	11451FA	V16.3	\$22.99
Polished Chrome	165°F	11451FC	V16.3	\$22.99
Painted White	135°F	11451MA/SW1004	V16.3	\$22.99
Painted White	165°F	11451MC/SW1004	V16.3	\$22.99
Brushed Chrome	135°F	11451FA/B	V16.3	\$28.77
Brushed Chrome	165°F	11451FC/B	V16.3	\$28.77
Painted Ivory	135°F	11451MA/SW1634	V16.3	\$28.77
Painted Ivory	165°F	11451MC/SW1634	V16.3	\$28.77
Painted Black	135°F	11451MA/SW1007	V16.3	\$28.77
Painted Black	165°F	11451MC/SW1007	V16.3	\$28.77
Bright Brass	135°F	11451BA	V16.3	\$28.77
Bright Brass	165°F	11451BC	V16.3	\$28.77



<b>Adapter</b>				
<b>Base Part #:</b>		11436		
<b>Finish</b>	<b>Temp</b>	<b>Part #</b>	<b>IPG</b>	<b>List Price</b>
Polished Chrome	N/A	11436F	V16.3	\$4.14
Brushed Chrome	N/A	11436F/B	V16.3	\$4.14
Painted White	N/A	11436M/SW1004	V16.3	\$4.14
Painted Ivory	N/A	11436M/SW1634	V16.3	\$4.14
Painted Black	N/A	11436M/SW1007	V16.3	\$4.14
Bright Brass	N/A	11436B	V16.3	\$5.88



(1) Cover plates and adapters sold separately. Covers are also available in custom colors at an additional charge (see pg. F-8).

				
Microfast® Model M Quick Response Standard Coverage FUSIBLE LINK <sup>1</sup> Upright Sprinklers				
Finish	Temp	Part #	IPG	List Price
<b>VK326 - 2.8 (40) K Factor - 1/2 in NPT - UPRIGHT (QR)</b>				
Standard Brass	165°F	13957AC	V14.2	\$43.06
Standard Brass	205°F	13957AE	V14.2	\$43.06
Standard Brass	280°F	13957AG	V14.2	\$43.06
Chrome	165°F	13957FC	V14.2	\$44.76
Chrome	205°F	13957FE	V14.2	\$44.76
Chrome	280°F	13957FG	V14.2	\$44.76
White-Polyester	165°F	13957MC/W	V14.2	\$47.95
White-Polyester	205°F	13957ME/W	V14.2	\$47.95
White-Polyester	280°F	13957MG/W	V14.2	\$47.95
<b>VK328 - 4.2 (60) K Factor - 1/2 in NPT - UPRIGHT (QR)</b>				
Standard Brass	165°F	13958AC	V20	\$41.21
Standard Brass	205°F	13958AE	V20	\$41.21
Standard Brass	280°F	13958AG	V20	\$41.21
Chrome	165°F	13958FC	V20	\$44.21
Chrome	205°F	13958FE	V20	\$44.21
Chrome	280°F	13958FG	V20	\$44.21
White-Polyester	165°F	13958MC/W	V20	\$44.21
White-Polyester	205°F	13958ME/W	V20	\$44.21
White-Polyester	280°F	13958MG/W	V20	\$44.21
<b>VK301 - 5.6 (81) K Factor - 1/2 in NPT - UPRIGHT (QR)</b>				
Standard Brass	165°F	12279AC	V13.3	\$41.31
Standard Brass	205°F	12279AE	V13.3	\$41.31
Standard Brass	280°F	12279AG	V13.3	\$41.31
Chrome	165°F	12279FC	V13.3	\$46.87
Chrome	205°F	12279FE	V13.3	\$46.87
Chrome	280°F	12279FG	V13.3	\$46.87
White-Polyester	165°F	12279MC/W	V13.3	\$46.87
White-Polyester	205°F	12279ME/W	V13.3	\$46.87
White-Polyester	280°F	12279MG/W	V13.3	\$46.87
Black-Polyester	165°F	12279MC/B	V20	\$48.24
Black-Polyester	205°F	12279ME/B	V20	\$48.24
Black-Polyester	280°F	12279MG/B	V20	\$48.24
<b>VK351 - 8.0 (115) K Factor - 3/4 in NPT - UPRIGHT (QR)</b>				
Standard Brass	165°F	13976AC	V14	\$39.34
Standard Brass	205°F	13976AE	V14	\$39.34
Standard Brass	280°F	13976AG	V14	\$39.34
Chrome	165°F	13976FC	V14	\$41.16
Chrome	205°F	13976FE	V14	\$41.16
Chrome	280°F	13976FG	V14	\$41.16
White-Polyester	165°F	13976MC/W	V14	\$43.44
White-Polyester	205°F	13976ME/W	V14	\$43.44
White-Polyester	280°F	13976MG/W	V14	\$43.44
Std Sprinkler Wrench		10896W/B	V20	\$49.85

				
Microfast® Model M Quick Response Standard Coverage FUSIBLE LINK <sup>1</sup> Pendent Sprinklers				
Finish	Temp	Part #	IPG	List Price
<b>VK330 - 2.8 (40) K Factor - 1/2 in NPT - PENDENT (QR)</b>				
Standard Brass	165°F	13960AC	V14.2	\$42.61
Standard Brass	205°F	13960AE	V14.2	\$42.61
Standard Brass	280°F	13960AG	V14.2	\$42.61
Chrome	165°F	13960FC	V14.2	\$44.31
Chrome	205°F	13960FE	V14.2	\$44.31
Chrome	280°F	13960FG	V14.2	\$44.31
White-Polyester	165°F	13960MC/W	V14.2	\$47.49
White-Polyester	205°F	13960ME/W	V14.2	\$47.49
White-Polyester	280°F	13960MG/W	V14.2	\$47.49
<b>VK332 - 4.2 (60) K Factor - 1/2 in NPT - PENDENT (QR)</b>				
Standard Brass	165°F	13961AC	V14.2	\$44.20
Standard Brass	205°F	13961AE	V14.2	\$44.20
Standard Brass	280°F	13961AG	V14.2	\$44.20
Chrome	165°F	13961FC	V14.2	\$46.92
Chrome	205°F	13961FE	V14.2	\$46.92
Chrome	280°F	13961FG	V14.2	\$46.92
White-Polyester	165°F	13961MC/W	V14.2	\$46.92
White-Polyester	205°F	13961ME/W	V14.2	\$46.92
White-Polyester	280°F	13961MG/W	V14.2	\$46.92
<b>VK303 - 5.6 (81) K Factor - 1/2 in NPT - PENDENT (QR)</b>				
Standard Brass	165°F	12275AC	V13.3	\$41.31
Standard Brass	205°F	12275AE	V13.3	\$41.31
Standard Brass	280°F	12275AG	V13.3	\$41.31
Chrome	165°F	12275FC	V13.3	\$46.87
Chrome	205°F	12275FE	V13.3	\$46.87
Chrome	280°F	12275FG	V13.3	\$46.87
White-Polyester	165°F	12275MC/W	V13.3	\$46.87
White-Polyester	205°F	12275ME/W	V13.3	\$46.87
White-Polyester	280°F	12275MG/W	V13.3	\$46.87
Black-Polyester	165°F	12275MC/B	V20	\$48.24
Black-Polyester	205°F	12275ME/B	V20	\$48.24
Black-Polyester	280°F	12275MG/B	V20	\$48.24
<b>VK353 - 8.0 (115) K Factor - 3/4 in NPT - PENDENT (QR)</b>				
Standard Brass	165°F	13975AC	V14	\$37.06
Standard Brass	205°F	13975AE	V14	\$37.06
Standard Brass	280°F	13975AG	V14	\$37.06
Chrome	165°F	13975FC	V14	\$38.86
Chrome	205°F	13975FE	V14	\$38.86
Chrome	280°F	13975FG	V14	\$38.86
White-Polyester	165°F	13975MC/W	V14	\$40.58
White-Polyester	205°F	13975ME/W	V14	\$40.58
White-Polyester	280°F	13975MG/W	V14	\$40.58
Std Sprinkler Wrench		10896W/B	V20	\$49.85
Wrench for Recessed		12144W/B	V20	\$101.92

(1) Select fusible link sprinklers are also available in painted black and black teflon® finish.  
Contact customer service for price and availability.

					<b>Microfast® Model M</b>				
					<b>Quick Response</b>				
					<b>Standard Coverage</b>				
					<b>FUSIBLE LINK<sup>1</sup></b>				
<b>Horizontal Sidewall</b>									
Finish	Temp	Part #	IPG	List Price					
<b>VK334 - 2.8 (40) K Factor - 1/2 in NPT - HSW (QR)</b>									
Standard Brass	165°F	13962AC	V20	\$40.34					
Standard Brass	205°F	13962AE	V20	\$40.34					
Standard Brass	280°F	13962AG	V20	\$40.34					
Chrome	165°F	13962FC	V20	\$42.41					
Chrome	205°F	13962FE	V14.2	\$42.41					
Chrome	280°F	13962FG	V14.2	\$42.41					
White-Polyester	165°F	13962MC/W	V14.2	\$42.41					
White-Polyester	205°F	13962ME/W	V14.2	\$42.41					
White-Polyester	280°F	13962MG/W	V14.2	\$42.41					
<b>VK307 - 5.6 (81) K Factor - 1/2 in NPT - HSW - LH</b>									
Standard Brass	165°F	13948AC	V13	\$45.72					
Standard Brass	205°F	13948AE	V13	\$45.72					
Standard Brass	280°F	13948AG	V13	\$45.72					
Chrome	165°F	13948FC	V13	\$47.55					
Chrome	205°F	13948FE	V13	\$47.55					
Chrome	280°F	13948FG	V13	\$47.55					
White-Polyester	165°F	13948MC/W	V13	\$52.25					
White-Polyester	205°F	13948ME/W	V13	\$52.25					
White-Polyester	280°F	13948MG/W	V13	\$52.25					
<b>VK308 - 5.6 (81) K Factor - 1/2 in NPT - HSW - OH</b>									
Standard Brass	165°F	13950AC	V13	\$46.95					
Standard Brass	205°F	13950AE	V13	\$46.95					
Standard Brass	280°F	13950AG	V13	\$46.95					
Chrome	165°F	13950FC	V13.1	\$48.79					
Chrome	205°F	13950FE	V13.1	\$48.79					
Chrome	280°F	13950FG	V13.1	\$48.79					
White-Polyester	165°F	13950MC/W	V13.2	\$52.49					
White-Polyester	205°F	13950ME/W	V13.2	\$52.49					
White-Polyester	280°F	13950MG/W	V13.2	\$52.49					
Std Sprinkler Wrench		10896W/B	V20	\$49.85					
Wrench for Recessed		13655W/B	V20	\$104.77					

					<b>Microfast® Model M</b>				
					<b>Quick Response</b>				
					<b>Standard Coverage</b>				
					<b>FUSIBLE LINK<sup>1</sup></b>				
<b>Conventional</b>									
Finish	Temp	Part #	IPG	List Price					
<b>VK311 - 5.6 (81) K Factor - 1/2 in NPT - Conventional</b>									
Standard Brass	165°F	13952AC	V13	\$39.80					
Standard Brass	205°F	13952AE	V13	\$39.80					
Standard Brass	280°F	13952AG	V13	\$39.80					
Chrome	165°F	13952FC	V13.1	\$42.68					
Chrome	205°F	13952FE	V13.1	\$42.68					
Chrome	280°F	13952FG	V13.1	\$42.68					
White-Polyester	165°F	13952MC/W	V13.2	\$42.68					
White-Polyester	205°F	13952ME/W	V13.2	\$42.68					
White-Polyester	280°F	13952MG/W	V13.2	\$42.68					
Std Sprinkler Wrench		10896W/B	V20	\$49.85					

					<b>Microfast® Model M</b>				
					<b>Quick Response</b>				
					<b>Standard Coverage</b>				
					<b>FUSIBLE LINK<sup>1</sup></b>				
<b>Vertical Sidewall</b>									
Finish	Temp	Part #	IPG	List Price					
<b>VK309 - 5.6 (81) K Factor - 1/2 in NPT - VSW - LH</b>									
Standard Brass	165°F	13951AC	V20	\$41.80					
Standard Brass	205°F	13951AE	V20	\$41.80					
N/A									
Chrome	165°F	13951FC	V20	\$45.52					
Chrome	205°F	13951FE	V20	\$45.52					
N/A									
Std Sprinkler Wrench		10896W/B	V20	\$49.85					

					<b>Microfast® Model M</b>				
					<b>Quick Response</b>				
					<b>Standard Coverage</b>				
					<b>FUSIBLE LINK<sup>1</sup></b>				
<b>Conventional</b>									
Finish	Temp	Part #	IPG	List Price					
<b>VK355 - 8.0 (115) K Factor - 3/4 in NPT - Conventional</b>									
Standard Brass	165°F	13979AC	V20	\$38.28					
Standard Brass	205°F	13979AE	V20	\$38.28					
Standard Brass	280°F	13979AG	V20	\$38.28					
Chrome	165°F	13979FC	V20	\$41.58					
Chrome	205°F	13979FE	V20	\$41.58					
Chrome	280°F	13979FG	V20	\$41.58					
White-Polyester	165°F	13979MC/W	V20	\$41.58					
White-Polyester	205°F	13979ME/W	V20	\$41.58					
White-Polyester	280°F	13979MG/W	V20	\$41.58					
Std Sprinkler Wrench		10896W/B	V20	\$49.85					

(1) Select fusible link sprinklers also available in Black-Polyester finish (contact customer service for price & availability).

	<b>Microfast® Model M</b>			
	<b>Quick Response</b>			
	<b>Standard Coverage</b>			
	<b>FUSIBLE LINK<sup>1</sup></b>			
	<b>Upright</b>			
<b>HIGH PRESSURE</b>				
<b>Finish</b>	<b>Temp</b>	<b>Part #</b>	<b>IPG</b>	<b>List Price</b>
<b>VK341 - 2.8 (40) K Factor - 1/2 in NPT - UPRIGHT (HP)</b>				
Standard Brass	165°F	13963AC	V14.2	\$44.20
Standard Brass	205°F	13963AE	V14.2	\$44.20
Standard Brass	280°F	13963AG	V14.2	\$44.20
Chrome	165°F	13963FC	V14.2	\$46.92
Chrome	205°F	13963FE	V14.2	\$46.92
Chrome	280°F	13963FG	V14.2	\$46.92
White-Polyester	165°F	13963MC/W	V14.2	\$46.92
White-Polyester	205°F	13963ME/W	V14.2	\$46.92
White-Polyester	280°F	13963MG/W	V14.2	\$46.92
<b>VK316 - 5.6 (81) K Factor - 1/2 in NPT - UPRIGHT (HP)</b>				
Standard Brass	165°F	13953AC	V13	\$41.21
Standard Brass	205°F	13953AE	V13	\$41.21
Standard Brass	280°F	13953AG	V13	\$41.21
Chrome	165°F	13953FC	V13.1	\$44.03
Chrome	205°F	13953FE	V13.1	\$44.03
Chrome	280°F	13953FG	V13.1	\$44.03
White-Polyester	165°F	13953MC/W	V13.2	\$44.03
White-Polyester	205°F	13953ME/W	V13.2	\$44.03
White-Polyester	280°F	13953MG/W	V13.2	\$44.03
Std Sprinkler Wrench		10896W/B	V20	\$49.85

	<b>Microfast® Model M</b>			
	<b>Quick Response</b>			
	<b>Standard Coverage</b>			
	<b>FUSIBLE LINK<sup>1</sup></b>			
	<b>Horizontal Sidewall</b>			
<b>HIGH PRESSURE</b>				
<b>Finish</b>	<b>Temp</b>	<b>Part #</b>	<b>IPG</b>	<b>List Price</b>
<b>VK346 - 2.8 (40) K Factor - 1/2 in NPT - HSW (HP)</b>				
Standard Brass	165°F	13965AC	V20	\$44.06
Standard Brass	205°F	13965AE	V20	\$44.06
Standard Brass	280°F	13965AG	V20	\$44.06
Chrome	165°F	13965FC	V20	\$46.56
Chrome	205°F	13965FE	V20	\$46.56
Chrome	280°F	13965FG	V20	\$46.56
White-Polyester	165°F	13965MC/W	V20	\$46.56
White-Polyester	205°F	13965ME/W	V20	\$46.56
White-Polyester	280°F	13965MG/W	V20	\$46.56
Std Sprinkler Wrench		10896W/B	V20	\$49.85
Wrench for Recessed		13577W/B	V20	\$92.65

	<b>Microfast® Model M</b>			
	<b>Quick Response</b>			
	<b>Standard Coverage</b>			
	<b>FUSIBLE LINK<sup>1</sup></b>			
	<b>Pendent</b>			
<b>HIGH PRESSURE</b>				
<b>Finish</b>	<b>Temp</b>	<b>Part #</b>	<b>IPG</b>	<b>List Price</b>
<b>VK343 - 2.8 (40) K Factor - 1/2 in NPT - PENDENT (HP)</b>				
Standard Brass	165°F	13964AC	V13	\$46.09
Standard Brass	205°F	13964AE	V13	\$46.09
Standard Brass	280°F	13964AG	V13	\$46.09
Chrome	165°F	13964FC	V13.1	\$50.68
Chrome	205°F	13964FE	V13.1	\$50.68
Chrome	280°F	13964FG	V13.1	\$50.68
White-Polyester	165°F	13964MC/W	V13.2	\$50.68
White-Polyester	205°F	13964ME/W	V13.2	\$50.68
White-Polyester	280°F	13964MG/W	V13.2	\$50.68
<b>VK318 - 5.6 (81) K Factor - 1/2 in NPT - PENDENT (HP)</b>				
Standard Brass	165°F	13954AC	V13	\$41.21
Standard Brass	205°F	13954AE	V13	\$41.21
Standard Brass	280°F	13954AG	V13	\$41.21
Chrome	165°F	13954FC	V13.1	\$43.91
Chrome	205°F	13954FE	V13.1	\$43.91
Chrome	280°F	13954FG	V13.1	\$43.91
White-Polyester	165°F	13954MC/W	V13.2	\$43.91
White-Polyester	205°F	13954ME/W	V13.2	\$43.91
White-Polyester	280°F	13954MG/W	V13.2	\$43.91
Std Sprinkler Wrench		10896W/B	V20	\$49.85
Wrench for Recessed		12144W/B	V20	\$101.92

	<b>Microfast® Model M</b>			
	<b>Quick Response</b>			
	<b>Standard Coverage</b>			
	<b>FUSIBLE LINK<sup>1</sup></b>			
	<b>Horizontal Sidewall</b>			
<b>HIGH PRESSURE</b>				
<b>Finish</b>	<b>Temp</b>	<b>Part #</b>	<b>IPG</b>	<b>List Price</b>
<b>VK320 - 5.6 (81) K Factor - 1/2 in NPT - HSW (HP)</b>				
Standard Brass	165°F	13955AC	V14	\$43.68
Standard Brass	205°F	13955AE	V14	\$43.68
Standard Brass	280°F	13955AG	V14	\$43.68
Chrome	165°F	13955FC	V14	\$46.35
Chrome	205°F	13955FE	V14	\$46.35
Chrome	280°F	13955FG	V14	\$46.35
White-Polyester	165°F	13955MC/W	V14	\$46.35
White-Polyester	205°F	13955ME/W	V14	\$46.35
White-Polyester	280°F	13955MG/W	V14	\$46.35
Std Sprinkler Wrench		10896W/B	V20	\$49.85
Wrench for Recessed		13577W/B	V20	\$92.65

(1) Select fusible link sprinklers are also available in Black-Polyester finish  
Contact customer service for price and availability.

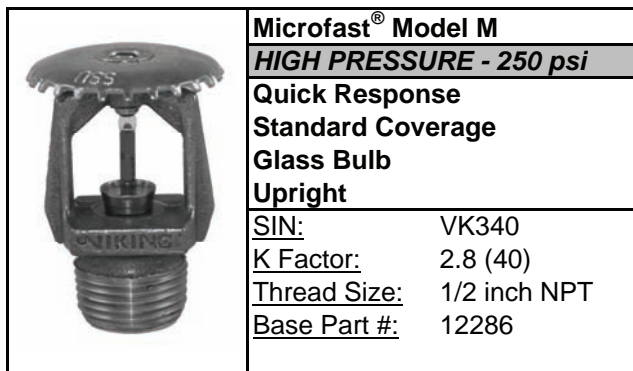

**Microfast® Model M**  
**HIGH PRESSURE - 250 psi**  
**Quick Response**  
**Standard Coverage**  
**Glass Bulb**  
**Upright**  
**SIN:** VK340  
**K Factor:** 2.8 (40)  
**Thread Size:** 1/2 inch NPT  
**Base Part #:** 12286

Finish	Temp	Part #	IPG	List Price
Standard Brass	155°F	12286AB	V14.2	\$38.56
Standard Brass	175°F	12286AD	V14.2	\$38.56
Standard Brass	200°F	12286AE	V14.2	\$38.56
Standard Brass	286°F	12286AG	V14.2	\$38.56
Chrome	155°F	12286FB	V14.2	\$41.32
Chrome	175°F	12286FD	V14.2	\$41.32
Chrome	200°F	12286FE	V14.2	\$41.32
Chrome	286°F	12286FG	V14.2	\$41.32
White-Polyester <sup>1</sup>	155°F	12286MB/W	V14.2	\$41.32
White-Polyester	175°F	12286MD/W	V14.2	\$41.32
White-Polyester	200°F	12286ME/W	V14.2	\$41.32
White-Polyester	286°F	12286MG/W	V14.2	\$41.32
Black-Polyester <sup>1</sup>	155°F	12286MB/B	V20	\$42.53
Black-Polyester	175°F	12286MD/B	V20	\$42.53
Black-Polyester	200°F	12286ME/B	V20	\$42.53
Black-Polyester	286°F	12286MG/B	V20	\$42.53
Black-Teflon <sup>1,2</sup>	155°F	12286NB	V20	\$51.71
Black-Teflon	175°F	12286ND	V20	\$51.71
Black-Teflon	200°F	12286NE	V20	\$51.71
Black-Teflon	286°F	12286NG	V20	\$51.71
Std Sprinkler Wrench		10896W/B	V20	\$49.85

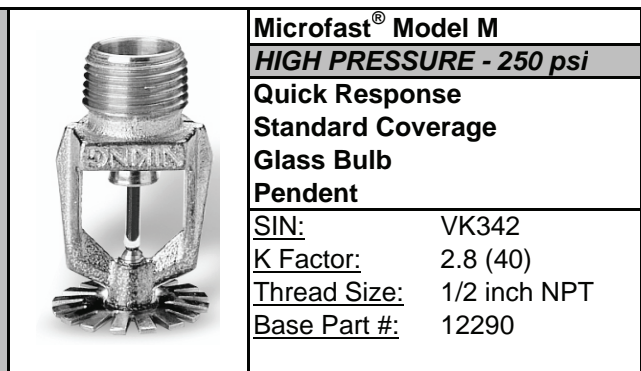

**Microfast® Model M**  
**HIGH PRESSURE - 250 psi**  
**Quick Response**  
**Standard Coverage**  
**Glass Bulb**  
**Pendent**  
**SIN:** VK342  
**K Factor:** 2.8 (40)  
**Thread Size:** 1/2 inch NPT  
**Base Part #:** 12290

Finish	Temp	Part #	IPG	List Price
Standard Brass	155°F	12290AB	V13	\$38.56
Standard Brass	175°F	12290AD	V13	\$38.56
Standard Brass	200°F	12290AE	V13	\$38.56
Standard Brass	286°F	12290AG	V13	\$38.56
Chrome	155°F	12290FB	V13.1	\$41.32
Chrome	175°F	12290FD	V13.1	\$41.32
Chrome	200°F	12290FE	V13.1	\$41.32
Chrome	286°F	12290FG	V13.1	\$41.32
White-Polyester <sup>1</sup>	155°F	12290MB/W	V13.2	\$41.32
White-Polyester	175°F	12290MD/W	V13.2	\$41.32
White-Polyester	200°F	12290ME/W	V13.2	\$41.32
White-Polyester	286°F	12290MG/W	V13.2	\$41.32
Black-Polyester <sup>1</sup>	155°F	12290MB/B	V20	\$42.53
Black-Polyester	175°F	12290MD/B	V20	\$42.53
Black-Polyester	200°F	12290ME/B	V20	\$42.53
Black-Polyester	286°F	12290MG/B	V20	\$42.53
Black-Teflon <sup>1,2</sup>	155°F	12290NB	V20	\$51.71
Black-Teflon	175°F	12290ND	V20	\$51.71
Black-Teflon	200°F	12290NE	V20	\$51.71
Black-Teflon	286°F	12290NG	V20	\$51.71
Std Sprinkler Wrench		10896W/B	V20	\$49.85
Wrench for Recessed		12144W/B	V20	\$101.92

(1) Polyester and Teflon® sprinklers are suitable for decorative applications and are UL listed for corrosion resistance.  
(2) Teflon® sprinklers are also available with coated waterways without glass bulbs.

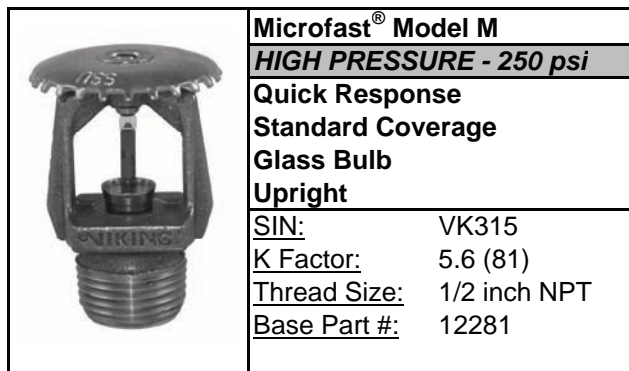

Finish	Temp	Part #	IPG	List Price
Standard Brass	155°F	12281AB	V13	\$32.31
Standard Brass	175°F	12281AD	V13	\$32.31
Standard Brass	200°F	12281AE	V13	\$32.31
Standard Brass	286°F	12281AG	V13	\$32.31
Chrome	155°F	12281FB	V13.1	\$34.95
Chrome	175°F	12281FD	V13.1	\$34.95
Chrome	200°F	12281FE	V13.1	\$34.95
Chrome	286°F	12281FG	V13.1	\$34.95
White-Polyester <sup>1</sup>	155°F	12281MB/W	V13.2	\$34.95
White-Polyester	175°F	12281MD/W	V13.2	\$34.95
White-Polyester	200°F	12281ME/W	V13.2	\$34.95
White-Polyester	286°F	12281MG/W	V13.2	\$34.95
Black-Polyester <sup>1</sup>	155°F	12281MB/B	V20	\$35.97
Black-Polyester	175°F	12281MD/B	V20	\$35.97
Black-Polyester	200°F	12281ME/B	V20	\$35.97
Black-Polyester	286°F	12281MG/B	V20	\$35.97
Black-Teflon <sup>1,2</sup>	155°F	12281NB	V20	\$46.39
Black-Teflon	175°F	12281ND	V20	\$46.39
Black-Teflon	200°F	12281NE	V20	\$46.39
Black-Teflon	286°F	12281NG	V20	\$46.39
Std Sprinkler Wrench		10896W/B	V20	\$49.85

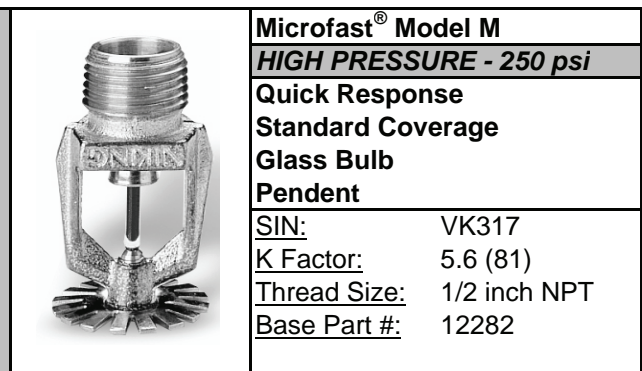

Finish	Temp	Part #	IPG	List Price
Standard Brass	155°F	12282AB	V13	\$32.31
Standard Brass	175°F	12282AD	V13	\$32.31
Standard Brass	200°F	12282AE	V13	\$32.31
Standard Brass	286°F	12282AG	V13	\$32.31
Chrome	155°F	12282FB	V13.1	\$34.95
Chrome	175°F	12282FD	V13.1	\$34.95
Chrome	200°F	12282FE	V13.1	\$34.95
Chrome	286°F	12282FG	V13.1	\$34.95
White-Polyester <sup>1</sup>	155°F	12282MB/W	V13.2	\$34.95
White-Polyester	175°F	12282MD/W	V13.2	\$34.95
White-Polyester	200°F	12282ME/W	V13.2	\$34.95
White-Polyester	286°F	12282MG/W	V13.2	\$34.95
Black-Polyester <sup>1</sup>	155°F	12282MB/B	V20	\$35.97
Black-Polyester	175°F	12282MD/B	V20	\$35.97
Black-Polyester	200°F	12282ME/B	V20	\$35.97
Black-Polyester	286°F	12282MG/B	V20	\$35.97
Black-Teflon <sup>1,2</sup>	155°F	12282NB	V13	\$45.08
Black-Teflon	175°F	12282ND	V13	\$45.08
Black-Teflon	200°F	12282NE	V13	\$45.08
Black-Teflon	286°F	12282NG	V13	\$45.08
Std Sprinkler Wrench		10896W/B	V20	\$49.85
Wrench for Recessed		12144W/B	V20	\$101.92

- (1) Polyester and Teflon® sprinklers are suitable for decorative applications and are UL listed for corrosion resistance.
- (2) Teflon® sprinklers are also available with coated waterways without glass bulbs.

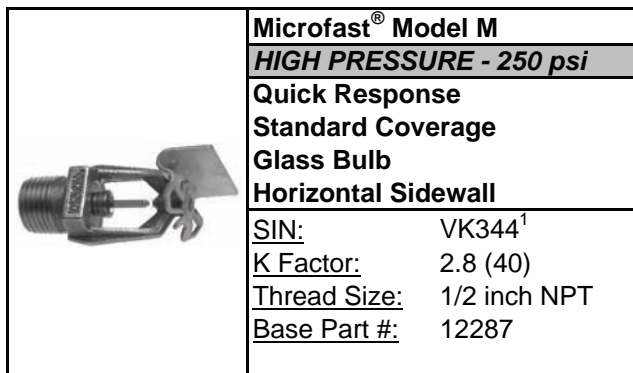

**Microfast® Model M**  
**HIGH PRESSURE - 250 psi**  
**Quick Response**  
**Standard Coverage**  
**Glass Bulb**  
**Horizontal Sidewall**  
SIN: VK344<sup>1</sup>  
K Factor: 2.8 (40)  
Thread Size: 1/2 inch NPT  
Base Part #: 12287

Finish	Temp	Part #	IPG	List Price
Standard Brass	155°F	12287AB	V20	\$40.16
Standard Brass	175°F	12287AD	V20	\$40.16
Standard Brass	200°F	12287AE	V20	\$40.16
Standard Brass	286°F	12287AG	V20	\$40.16
Chrome	155°F	12287FB	V20	\$42.59
Chrome	175°F	12287FD	V20	\$42.59
Chrome	200°F	12287FE	V20	\$42.59
Chrome	286°F	12287FG	V20	\$42.59
White-Polyester <sup>3</sup>	155°F	12287MB/W	V20	\$42.59
White-Polyester	175°F	12287MD/W	V20	\$42.59
White-Polyester	200°F	12287ME/W	V20	\$42.59
White-Polyester	286°F	12287MG/W	V20	\$42.59
Black-Polyester <sup>3</sup>	155°F	12287MB/B	V20	\$42.59
Black-Polyester	175°F	12287MD/B	V20	\$42.59
Black-Polyester	200°F	12287ME/B	V20	\$42.59
Black-Polyester	286°F	12287MG/B	V20	\$42.59
Black-Teflon <sup>3,4</sup>	155°F	12287NB	V20	\$55.75
Black-Teflon	175°F	12287ND	V20	\$55.75
Black-Teflon	200°F	12287NE	V20	\$55.75
Black-Teflon	286°F	12287NG	V20	\$55.75
Std Sprinkler Wrench		10896W/B	V20	\$49.85
Wrench for Recessed		13655W/B	V20	\$104.77

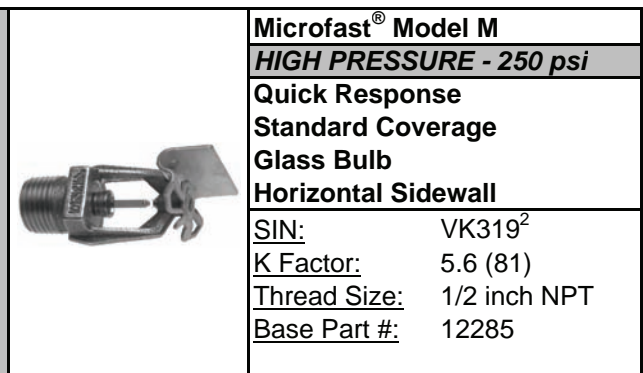

**Microfast® Model M**  
**HIGH PRESSURE - 250 psi**  
**Quick Response**  
**Standard Coverage**  
**Glass Bulb**  
**Horizontal Sidewall**  
SIN: VK319<sup>2</sup>  
K Factor: 5.6 (81)  
Thread Size: 1/2 inch NPT  
Base Part #: 12285

Finish	Temp	Part #	IPG	List Price
Standard Brass	155°F	12285AB	V14	\$37.14
Standard Brass	175°F	12285AD	V14	\$37.14
Standard Brass	200°F	12285AE	V14	\$37.14
Standard Brass	286°F	12285AG	V14	\$37.14
Chrome	155°F	12285FB	V14	\$39.96
Chrome	175°F	12285FD	V14	\$39.96
Chrome	200°F	12285FE	V14	\$39.96
Chrome	286°F	12285FG	V14	\$39.96
White-Polyester <sup>3</sup>	155°F	12285MB/W	V14	\$39.96
White-Polyester	175°F	12285MD/W	V14	\$39.96
White-Polyester	200°F	12285ME/W	V14	\$39.96
White-Polyester	286°F	12285MG/W	V14	\$39.96
Black-Polyester <sup>3</sup>	155°F	12285MB/B	V20	\$41.12
Black-Polyester	175°F	12285MD/B	V20	\$41.12
Black-Polyester	200°F	12285ME/B	V20	\$41.12
Black-Polyester	286°F	12285MG/B	V20	\$41.12
Black-Teflon <sup>3,4</sup>	155°F	12285NB	V20	\$50.63
Black-Teflon	175°F	12285ND	V20	\$50.63
Black-Teflon	200°F	12285NE	V20	\$50.63
Black-Teflon	286°F	12285NG	V20	\$50.63
Std Sprinkler Wrench		10896W/B	V20	\$49.85
Wrench for Recessed		13655W/B	V20	\$104.77

- (1) Light hazard
- (2) Light / Ordinary hazard
- (3) Polyester and Teflon® sprinklers are suitable for decorative applications and are UL listed for corrosion resistance.
- (4) Teflon® sprinklers are also available with coated waterways without glass bulbs.



**Microfast® - Stainless Steel**  
**CORROSION RESISTANT**  
**Quick Response**  
**Standard Coverage**  
**Glass Bulb**  
**Stainless Steel - Upright**  
SIN: VK338  
K Factor: 5.6 (81)  
Thread Size: 1/2 inch NPT  
Base Part #: 14692

Finish	Temp	Part #	IPG	List Price
Stainless Steel	135°F	14692A	V20.3	\$363.39
Stainless Steel	155°F	14692B	V20.3	\$363.39
Stainless Steel	175°F	14692D	V20.3	\$363.39
Stainless Steel	200°F	14692E	V20.3	\$363.39
Stainless Steel	286°F	14692G	V20.3	\$363.39
Std Sprinkler Wrench		10896W/B	V20	\$49.85



**Microfast® - Stainless Steel**  
**CORROSION RESISTANT**  
**Quick Response**  
**Standard Coverage**  
**Glass Bulb**  
**Stainless Steel - Pendent**  
SIN: VK339  
K Factor: 5.6 (81)  
Thread Size: 1/2 inch NPT  
Base Part #: 14693

Finish	Temp	Part #	IPG	List Price
Stainless Steel	135°F	14693A	V20.3	\$363.39
Stainless Steel	155°F	14693B	V20.3	\$363.39
Stainless Steel	175°F	14693D	V20.3	\$363.39
Stainless Steel	200°F	14693E	V20.3	\$363.39
Stainless Steel	286°F	14693G	V20.3	\$363.39
Std Sprinkler Wrench		10896W/B	V20	\$49.85

**Cocoon Style Sprinklers - Standard Coverage, Quick Response**



- Cocoon sprinkler package includes the following:**
- Pendent or horizontal sidewall sprinkler with protective cap or clip
  - Model E-1 two-piece escutcheon (adapter threaded onto sprinkler)
  - Three wraps of Teflon® tape
  - Entire unit is protected by plastic cap
  - Escutcheon cup is included in separate box

\* NOTE: Other pendent and horizontal sidewall sprinklers are available in cocoon configuration upon request.

**Pendent - Cocoon Sprinkler - QR**  
SIN: VK302  
K Factor: 5.6 (81)  
Thread Size: 1/2 inch NPT  
Base Part #: 06662

Finish	Temp	Part #	IPG	List Price
Chrome	135°F	06662BFAK	V00	\$45.04
Chrome	155°F	06662BFBK	V00	\$45.04
Chrome	175°F	06662BFDK	V00	\$45.04
Chrome	200°F	06662BFEK	V00	\$45.04
White-Polyester <sup>1</sup>	135°F	06662MA/WK	V00	\$45.04
White-Polyester	155°F	06662MB/WK	V00	\$45.04
White-Polyester	175°F	06662MD/WK	V00	\$45.04
White-Polyester	200°F	06662ME/WK	V00	\$45.04

**HIGH PRESSURE - VK317 - 5.6 (81) K Factor - Pendent**

Chrome	135°F	12282FAK	V00	\$46.74
Chrome	155°F	12282FBK	V00	\$46.74
Chrome	175°F	12282FDK	V00	\$46.74
Chrome	200°F	12282FEK	V00	\$46.74
White-Polyester <sup>1</sup>	135°F	12282MA/WK	V00	\$46.74
White-Polyester	155°F	12282MB/WK	V00	\$46.74
White-Polyester	175°F	12282MD/WK	V00	\$46.74
White-Polyester	200°F	12282ME/WK	V00	\$46.74
Std Sprinkler Wrench		10896W/B	V20	\$49.85
Wrench for Recessed		12144W/B	V20	\$101.92

**Horizontal Sidewall - Cocoon Sprinkler - QR**  
SIN: VK305  
K Factor: 5.6 (81)  
Thread Size: 1/2 inch NPT  
Base Part #: 12121

Finish	Temp	Part #	IPG	List Price
Chrome	135°F	12121ABK	V00	\$57.48
Chrome	155°F	12121FBK	V00	\$57.48
Chrome	175°F	12121FDK	V00	\$57.48
Chrome	200°F	12121FEK	V00	\$57.48
White-Polyester <sup>1</sup>	135°F	12121MA/WK	V00	\$57.48
White-Polyester	155°F	12121MB/WK	V00	\$57.48
White-Polyester	175°F	12121MD/WK	V00	\$57.48
White-Polyester	200°F	12121ME/WK	V00	\$57.48

**HIGH PRESSURE - VK319 - 5.6 (81) K Factor - Sidewall**

Chrome	135°F	12285FAK	V00	\$59.65
Chrome	155°F	12285FBK	V00	\$59.65
Chrome	175°F	12285FDK	V00	\$59.65
Chrome	200°F	12285FEK	V00	\$59.65
White-Polyester <sup>1</sup>	135°F	12285MA/WK	V00	\$59.65
White-Polyester	155°F	12285MB/WK	V00	\$59.65
White-Polyester	175°F	12285MD/WK	V00	\$59.65
White-Polyester	200°F	12285ME/WK	V00	\$59.65
Std Sprinkler Wrench		10896W/B	V20	\$49.85
Wrench for Recessed		13655W/B	V20	\$104.77

